



**CARATTERISTICHE TECNICHE**  
 TECHNICAL CHARACTERISTICS  
 TECHNISCHE ANGABEN  
 CARACTÉRISTIQUES TECHNIQUES  
 CARACTERÍSTICAS TÉCNICAS  
 CARACTERÍSTICAS TÉCNICAS



**Norma di Riferimento**

Reference standard

Entspricht der Norm

Norme de référence

Normativa de referencia

Norma de referència

1907/2006  
 REACH ✓

2011/65/CE  
 RoHS ✓

PED  
 2014/68/UE

SILICON  
 FREE

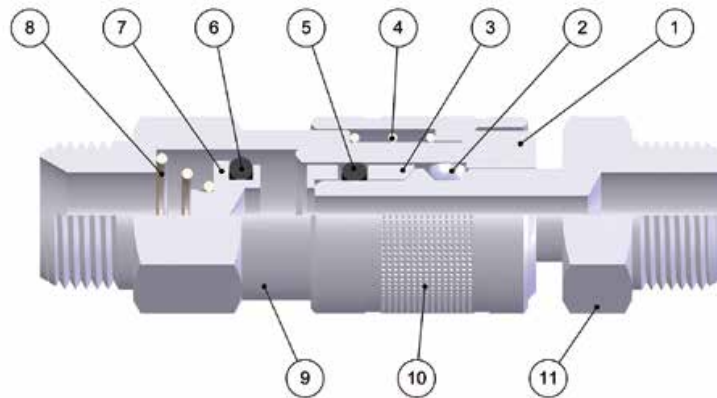

**FKM A RICHIESTA**  
 IF REQUESTED FKM  
 FKM AUF ANFRAGE  
 FKM SUR DEMANDE  
 FKM BAJO DEMANDA  
 FKM SOB ENCOMENDA

DN  
 2,5 mm

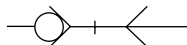

UNI ISO 6150 A-6

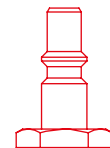

1:1

Materiali e Componenti	IT	Component Parts and Materials	GB	Komponenten und Materialien	DE
1 Corpo in Ottone Nichelato		1 Nickel-Plated Brass Body		1 Körper Messing Vernickelt	
2 Sfera in Acciaio AISI 420		2 Stainless Steel AISI 420 Balls		2 Kugel Edelstahl AISI 420	
3 Anello Guida Innesto in Ottone Nichelato		3 Nickel-Plated Brass Guide Ring Coupling		3 Stecker Führungsring Messing Vernickelt	
4 Molla Ghiera in Acciaio AISI 302		4 Stainless Steel AISI 302 Ring Nut Spring		4 Entriegelungsfeder Edelstahl AISI 302	
5 Guarnizione O-Ring in NBR		5 NBR O-Ring Seals		5 O-Ring NBR	
6 Guarnizione O-Ring in NBR		6 NBR O-Ring Seals		6 O-Ring NBR	
7 Otturatore in Ottone Nichelato		7 Nickel-Plated Brass Shutter		7 Verschluss Messing	
8 Molla Otturatore in Acciaio AISI 302		8 Stainless Steel AISI 302 Shutter Spring		8 Verschlussfeder Edelstahl AISI 302	
9 Attacco Terminale in Ottone Nichelato		9 Nickel-Plated Brass Coupling Back Part		9 Einschraubkörper Messing Vernickelt	
10 Ghiera in Ottone Nichelato		10 Nickel-Plated Brass Sleeve		10 Entriegelungshülse Messing Vernickelt	
11 Innesto in Ottone Nichelato		11 Nickel-Plated Brass Plug Outline		11 Stecker Messing Vernickelt	
Matériaux et Composants	FR	Materiales y Componentes	ES	Materials e Componentes	PT
1 Corps: Laiton Nickelé		1 Cuerpo en latón niquelado		1 Corpo em Latão Niquelado	
2 Bille: Acier Inoxydable AISI 420		2 Esfera en acero AISI 420		2 Esfera em aço AISI 420	
3 Bague de Guidage: Laiton Nickelé		3 Anillo guía enchufe en latón niquelado		3 Anel guia do plug em latão niquelado	
4 Ressort de Bague: Acier Inoxydable AISI 302		4 Muelle tuerca en acero AISI 302		4 Mola da porca em aço AISI 302	
5 Joint Torique en NBR		5 Junta tórica en NBR		5 Vedação O-Ring em NBR	
6 Joint Torique en NBR		6 Junta tórica en NBR		6 Vedação O-Ring em NBR	
7 Clapet: Laiton		7 Obturador en latón niquelado		7 Obturador em latão niquelado	
8 Ressort de Clapet: Acier Inoxydable AISI 302		8 Muelle obturador en acero AISI 302		8 Mola do obturador em aço AISI 302	
9 Corps: Laiton Nickelé		9 Terminal de conexión en latón niquelado		9 Conexão terminal em latão niquelado	
10 Bague: Laiton Nickelé		10 Tuerca en latón niquelado		10 Porca em latão niquelado	
11 Embout: Laiton Nickelé		11 Enchufe en latón niquelado		11 Plug em latão niquelado	

Архангельск (8182)63-90-72  
 Астана (7172)727-132  
 Астрахань (8512)99-46-04  
 Барнаул (3852)73-04-60  
 Белгород (4722)40-23-64  
 Брянск (4832)59-03-52  
 Владивосток (423)249-28-31  
 Волгоград (844)278-03-48  
 Вологда (8172)26-41-59  
 Воронеж (473)204-51-73  
 Екатеринбург (343)384-55-89  
 Иваново (4932)77-34-06

Ижевск (3412)26-03-58  
 Иркутск (395)279-98-46  
 Казань (843)206-01-48  
 Калининград (4012)72-03-81  
 Калуга (4842)92-23-67  
 Кемерово (3842)65-04-62  
 Киров (8332)68-02-04  
 Краснодар (861)203-40-90  
 Красноярск (391)204-63-61  
 Курск (4712)77-13-04  
 Липецк (4742)52-20-81  
 Киргизия (996)312-96-26-47

Магнитогорск (3519)55-03-13  
 Москва (495)268-04-70  
 Мурманск (8152)59-64-93  
 Набережные Челны (8552)20-53-41  
 Нижний Новгород (831)429-08-12  
 Новокузнецк (3843)20-46-81  
 Новосибирск (383)227-86-73  
 Омск (3812)21-46-40  
 Орел (4862)44-53-42  
 Оренбург (3532)37-68-04  
 Пенза (8412)22-31-16  
 Казахстан (772)734-952-31

Пермь (342)205-81-47  
 Ростов-на-Дону (863)308-18-15  
 Рязань (4912)46-61-64  
 Самара (846)206-03-16  
 Санкт-Петербург (812)309-46-40  
 Саратов (845)249-38-78  
 Севастополь (8692)22-31-93  
 Симферополь (3652)67-13-56  
 Смоленск (4812)29-41-54  
 Сочи (862)225-72-31  
 Ставрополь (8652)20-65-13  
 Таджикистан (992)427-82-92-69

Сургут (3462)77-98-35  
 Тверь (4822)63-31-35  
 Томск (3822)98-41-53  
 Тула (4872)74-02-29  
 Тюмень (3452)66-21-18  
 Ульяновск (8422)24-23-59  
 Уфа (347)229-48-12  
 Хабаровск (4212)92-98-04  
 Челябинск (351)202-03-61  
 Череповец (8202)49-02-64  
 Ярославль (4852)69-52-93

**Pressione d'esercizio***Working Pressures**Betriebsdruck**Pression de service**Presión de Ejercicio**Pressão de Trabalho***0 bar****10 bar****Max pressione statica (no pulsazioni)***Maximum static pressure (no pulsations)**Maximaler statischer Betriebsdruck (ohne pulsations)**Pression statique maximale (sans pulsation)**Presión estática máxima (sin pulsaciones)**Pressão estática máxima (sem pulsações)***35 bar****Temperature***Temperatures**Temperatur**Températures**Temperaturas**Temperaturas***- 20 °C****+ 80 °C****Con O-ring in FKM***With FKM O-ring**Mit O-ring in FKM**Avec joints en FKM**Con junta tórica en FKM**Com O-ring em FKM***- 10 °C****+ 200 °C****Fluidi compatibili***Aria compressa**Fluids**Compressed air**Geeignete Medien**Druckluft**Fluides compatibles**Air comprimé**Fluidos compatibles**Aire comprimido**Fluidos compatíveis**Ar comprimido***Per altri fluidi, consultare l'ufficio tecnico Aignep.***For other fluids, consult the technical department Aignep.**Für andere Flüssigkeiten, kontaktieren Sie uns.**Pour d'autres fluides, veuillez nous consulter.**Para otros fluidos póngase en contacto con el departamento técnico Aignep.**Para outros fluidos consulte o departamento técnico da Aignep.***Portata****NI/min***Flow Rate**Durchflusswerte**Débit**Caudal de Flujo**Vazão*

6 bar Δ 1	6 bar Δ 0.5	6 bar *
240	190	320

*\* Scarico libero - Exhaust Free - Kostenlose Auspuff - Échappement libre - Escape Libre - Descarga livre.***Filettatura****IT***Gas cilindrica conforme ISO 228 Classe A.***Threads****GB***Parallel gas in conformity with ISO 228 Class A.***Gewindearten****DE***Zylindrisches Gewinde nach Norm ISO 228 Classe A.***Filetages****FR***Filetage cylindrique conforme: ISO 228 Classe A.***Roscas****ES***Gas cilindrica conforme ISO 228 Clase A.***Roscas****PT***Gas paralela conforme ISO 228 Classe A.*

# 101

## PRESA MASCHIO

MALE SOCKET  
 VERSCHLUSS-KUPPLUNG MIT AUSSENGEWINDE  
 COUPLEUR MÂLE  
 ENCHUFE MACHO  
 SOQUETE COM ROSCA MACHO

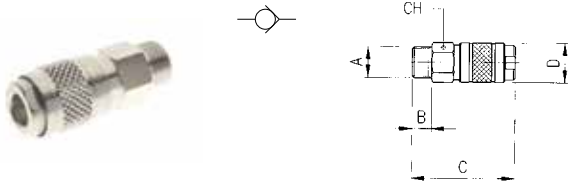

Code	A	B	C	D	CH	Pack.
00101 00 001	1/8	6	32	13	11	10

# 102

## PRESA FEMMINA

FEMALE SOCKET  
 VERSCHLUSS-KUPPLUNG MIT INNENGEWINDE  
 COUPLEUR FEMELLE  
 ENCHUFE HEMBRA  
 SOQUETE COM ROSCA FÊMEA

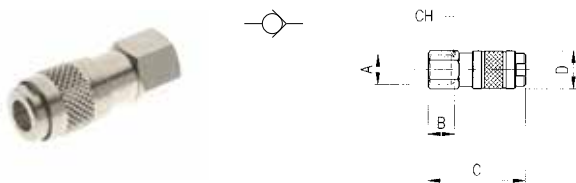

Code	A	B	C	D	CH	Pack.
00102 00 001	1/8	7.5	34	13	12	10

# 104

## PRESA A CALZAMENTO

COMPRESSION SOCKET  
 VERSCHLUSS-KUPPLUNG MIT ÜBERWURFVERSCHRAUBUNG  
 COUPLEUR RACCORD À COIFFE  
 ENCHUFE TUBO  
 SOQUETE COM CONEXÃO PUSH-ON

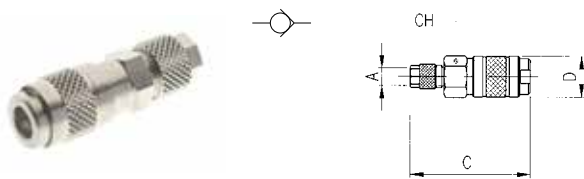

Code	A	C	D	CH	Pack.
00104 00 001	4/2.7	39	13	11	10
00104 00 002	6/4	40.5	13	11	10

# 105

## PRESA CON PORTAGOMMA A RESCA

SOCKET WITH REST FOR RUBBER HOSE  
 VERSCHLUSS-KUPPLUNG MIT SCHLAUCHTÜLLE  
 COUPLEUR À DOUILLE ANNELÉE POUR TUBE  
 ENCHUFE ESPIGA  
 SOQUETE COM ESPIGÃO PARA MANGUEIRA DE BORRACHA

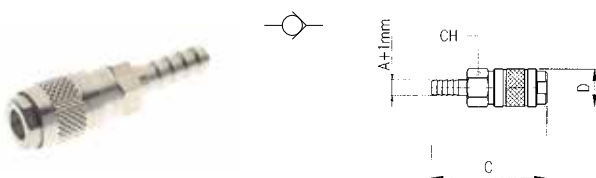

Code	A	C	D	CH	Pack.
00105 00 001	4	46.5	13	11	10
00105 00 002	6	46.5	13	11	10

## 201

### INNESTO MASCHIO

MALE PLUG  
 STECKER MIT AUSSENGEWINDE  
 EMBOUT MÂLE  
 ADAPTADOR MACHO  
 PLUG COM ROSCA MACHO

Code	A	B	C	CH	Pack.
00201 00 01 02 NB	1/8	6	26.5	11	10

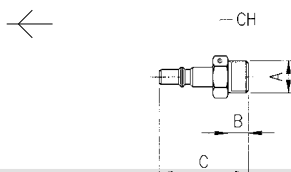

## 202

### INNESTO FEMMINA

FEMALE PLUG  
 STECKER MIT INNENGEWINDE  
 EMBOUT FEMELLE  
 ADAPTADOR HEMBRA  
 PLUG COM ROSCA FÊMEA

Code	A	B	C	CH	Pack.
00202 00 01 02 NB	1/8	7.5	25	12	10

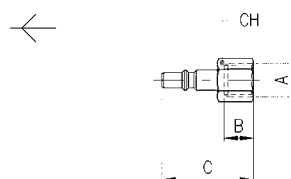

## 204

### INNESTO A CALZAMENTO

COMPRESSION PLUG  
 STECKER MIT ÜBERWURFVERSCHRAUBUNG  
 EMBOUT À RACCORD À COIFFE  
 ADAPTADOR TUBO  
 PLUG COM CONEXÃO PUSH-ON

Code	A	C	CH	Pack.
00204 00 001	4/2.7	32.5	11	10
00204 00 002	6/4	34	11	10

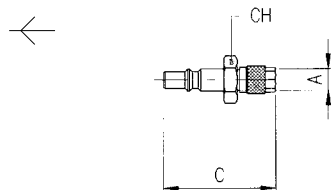

## 205

### INNESTO CON PORTAGOMMA A RESCA

PLUG WITH REST FOR RUBBER HOSE  
 STECKER MIT SCHLAUCHTÜLLE  
 EMBOUT À DOUILLE ANNELÉE POUR TUBE  
 ADAPTADOR ESPIGA  
 PLUG COM ESPIGÃO PARA TUBO DE BORRACHA

Code	A	C	D	Pack.
00205 00 01 X1 NB	4	38.5	11	10
00205 00 01 X4 NB	6	38.5	11	10

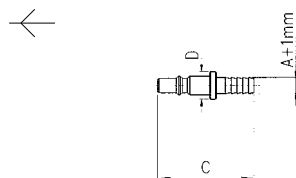

Архангельск (8182)63-90-72  
 Астана (7172)727-132  
 Астрахань (8512)99-46-04  
 Барнаул (3852)73-04-60  
 Белгород (4722)40-23-64  
 Брянск (4832)59-03-52  
 Владивосток (423)249-28-31  
 Волгоград (844)278-03-48  
 Вологда (8172)26-41-59  
 Воронеж (473)204-51-73  
 Екатеринбург (343)384-55-89  
 Иваново (4932)77-34-06

Ижевск (3412)26-03-58  
 Иркутск (395)279-98-46  
 Казань (843)206-01-48  
 Калининград (4012)72-03-81  
 Калуга (4842)92-23-67  
 Кемерово (3842)65-04-62  
 Киров (8332)68-02-04  
 Краснодар (861)203-40-90  
 Красноярск (391)204-63-61  
 Курск (4712)77-13-04  
 Липецк (4742)52-20-81  
 Киргизия (996)312-96-26-47

Магнитогорск (3519)55-03-13  
 Москва (495)268-04-70  
 Мурманск (8152)59-64-93  
 Набережные Челны (8552)20-53-41  
 Нижний Новгород (831)429-08-12  
 Новокузнецк (3843)20-46-81  
 Новосибирск (383)227-86-73  
 Омск (3812)21-46-40  
 Орел (4862)44-53-42  
 Оренбург (3532)37-68-04  
 Пенза (8412)22-31-16  
 Казахстан (772)734-952-31

Пермь (342)205-81-47  
 Ростов-на-Дону (863)308-18-15  
 Рязань (4912)46-61-64  
 Самара (846)206-03-16  
 Санкт-Петербург (812)309-46-40  
 Саратов (845)249-38-78  
 Севастополь (8692)22-31-93  
 Симферополь (3652)67-13-56  
 Смоленск (4812)29-41-54  
 Сочи (862)225-72-31  
 Ставрополь (8652)20-65-13  
 Таджикистан (992)427-82-92-69

Сургут (3462)77-98-35  
 Тверь (4822)63-31-35  
 Томск (3822)98-41-53  
 Тула (4872)74-02-29  
 Тюмень (3452)66-21-18  
 Ульяновск (8422)24-23-59  
 Уфа (347)229-48-12  
 Хабаровск (4212)92-98-04  
 Челябинск (351)202-03-61  
 Череповец (8202)49-02-64  
 Ярославль (4852)69-52-93