

**GIUNTI AD INNESTO RAPIDO A DOPPIA TENUTA**  
**AUTOMATIC QUICK COUPLINGS WITH DOUBLE SHUT-OFF**  
**KUPPLUNGEN MIT BEIDSEITIGER ABSPERRUNG**  
**COUPLEURS À DOUBLE OBTURATIONS**  
**ENCHUFES RÁPIDOS DE DOBLE OBTURACIÓN**  
**ENGATE RÁPIDO COM DUPLA RETENÇÃO**



**CARATTERISTICHE TECNICHE**

*TECHNICAL CHARACTERISTICS*  
*TECHNISCHE ANGABEN*  
*CARACTÉRISTIQUES TECHNIQUES*  
*CARACTERÍSTICAS TÉCNICAS*  
*CARACTERÍSTICAS TÉCNICAS*



**Norma di Riferimento**

*Reference standard*  
*Entspricht der Norm*  
*Norme de référence*  
*Normativa de referencia*  
*Norma de referência*

1907/2006 <b>REACH</b> ✓	2011/65/CE <b>RoHS</b> ✓
PED 2014/68/EU	SILICON FREE

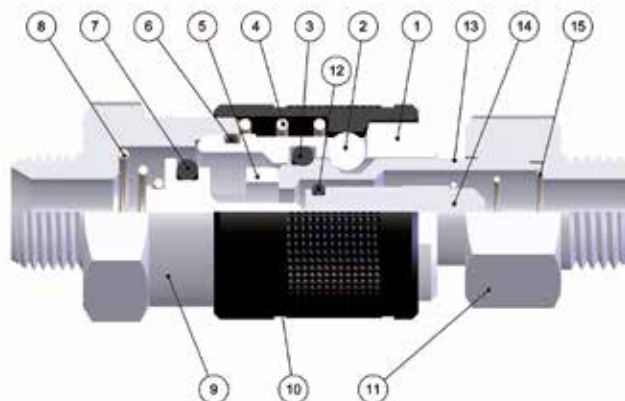

**FKM A RICHIESTA**  
**IF REQUESTED FKM**  
**FKM AUF ANFRAGE**  
**FKM SUR DEMANDE**  
**FKM BAJO DEMANDA**  
**FKM SOB ENCOMENDA**

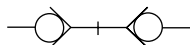
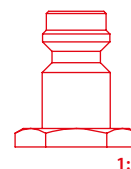

Materiali e Componenti	IT	Component Parts and Materials	GB	Komponenten und Materialien	DE
1 Corpo in Ottone Nichelato		1 Nickel-Plated Brass Body		1 Körper Messing Vernickelt	
2 Sfera in Acciaio AISI 420		2 Stainless Steel AISI 420 Balls		2 Kugel Edelstahl AISI 420	
3 Guarnizione O-Ring in NBR		3 NBR O-Ring Seals		3 O-Ring NBR	
4 Molla Ghiera in Acciaio AISI 302		4 Stainless Steel AISI 302 Ring Nut Spring		4 Entriegelungsfeder Edelstahl AISI 302	
5 Otturatore in Ottone		5 Brass Shutter		5 Verschluss Messing	
6 Guarnizione O-Ring in NBR		6 NBR O-Ring Seals		6 O-Ring NBR	
7 Guarnizione O-Ring in NBR		7 NBR O-Ring Seals		7 O-Ring NBR	
8 Molla Otturatore in Acciaio AISI 302		8 Stainless Steel AISI 302 Shutter Spring		8 Verschlussfeder Edelstahl AISI 302	
9 Attacco Terminale in Ottone Nichelato		9 Nickel-Plated Brass Coupling Back Part		9 Einschraubkörper Messing Vernickelt	
10 Ghiera in Ottone Zincato Nero		10 Black Zinc Plated Brass Sleeve		10 Entriegelungshülse Messing Schwarze Zink	
11 Innesto in Ottone Nichelato		11 Nickel-Plated Brass Plug Outline		11 Stecker Messing Vernickelt	
12 Guarnizione O-Ring Otturatore Innesto in NBR		12 NBR Plug Shutter O-Ring Seals		12 O-Ring NBR	
13 Profilo Innesto in Ottone Nichelato		13 Nickel-Plated Brass Profile Plug		13 Stecker Messing Vernickelt	
14 Otturatore Innesto in Ottone Nichelato		14 Nickel-Plated Brass Plug Shutter		14 Verschluss Messing Vernickelt	
15 Molla Otturatore Innesto in Acciaio AISI 302		15 Stainless Steel AISI 302 Plug Shutter Spring		15 Verschlussfeder Edelstahl AISI 302	

Matériaux et Composants	FR	Materiales y Componentes	ES	Materiais e Componentes	PT
1 Corps: Laiton Nickelé		1 Cuerpo en latón niquelado		1 Corpo em latão niquelado	
2 Bille: Acier Inoxydable AISI 420		2 Esfera en acero AISI 420		2 Esfera em aço AISI 420	
3 Joint Torique en NBR		3 Junta tórica en NBR		3 Vedação O-Ring em NBR	
4 Ressort de Bague: Acier Inoxydable AISI 302		4 Muelle tuerca en acero AISI 302		4 Mola da porca em aço AISI 302	
5 Clapet en Laiton		5 Obturador en latón		5 Obturador em Latão	
6 Joint Torique en NBR		6 Junta tórica en NBR		6 Vedação O-Ring em NBR	
7 Joint Torique en NBR		7 Junta tórica en NBR		7 Vedação O-Ring em NBR	
8 Ressort de Clapet: Acier Inoxydable AISI 302		8 Muelle obturador en acero AISI 302		8 Mola do obturador em aço AISI 302	
9 Corps: Laiton Nickelé		9 Conexión terminal en latón niquelado		9 Conexão terminal em latão niquelado	
10 Bague: Laiton Zinc Noir		10 Tuerca en latón Zinc Negro		10 Porca em latão zinco preto	
11 Embout: Laiton Nickelé		11 Enchufe en latón niquelado		11 Plug em latão niquelado	
12 Joint Torique en NBR		12 Junta tórica en NBR		12 Vedação O-Ring em NBR	
13 Embout: Laiton Nickelé		13 Perfil enchufe en latón niquelado		13 Perfil plug em latão niquelado	
14 Clapet en Laiton Nickelé		14 Obturado enchufe en latón niquelado		14 Obturador plug em latão niquelado	
15 Ressort de Clapet: Acier Inoxydable AISI 302		15 Muelle obturador en acero AISI 302		15 Mola do obturador em aço AISI 302	

Архангельск (8182)63-90-72  
 Астана (7172)727-132  
 Астрахань (8512)99-46-04  
 Барнаул (3852)73-04-60  
 Белгород (4722)40-23-64  
 Брянск (4832)59-03-52  
 Владивосток (423)249-28-31  
 Волгоград (844)278-03-48  
 Вологда (8172)26-41-59  
 Воронеж (473)204-51-73  
 Екатеринбург (343)384-55-89  
 Иваново (4932)77-34-06

Ижевск (3412)26-03-58  
 Иркутск (395)279-98-46  
 Казань (843)206-01-48  
 Калининград (4012)72-03-81  
 Калуга (4842)92-23-67  
 Кемерово (3842)65-04-62  
 Киров (8332)68-02-04  
 Краснодар (861)203-40-90  
 Красноярск (391)204-63-61  
 Курск (4712)77-13-04  
 Липецк (4742)52-20-81  
 Киргизия (996)312-96-26-47

Магнитогорск (3519)55-03-13  
 Москва (495)268-04-70  
 Мурманск (8152)59-64-93  
 Набережные Челны (8552)20-53-41  
 Нижний Новгород (831)429-08-12  
 Новокузнецк (3843)20-46-81  
 Новосибирск (383)227-86-73  
 Омск (3812)21-46-40  
 Орен (4862)44-53-42  
 Оренбург (3532)37-68-04  
 Пенза (8412)22-31-16  
 Казахстан (772)734-952-31

Пермь (342)205-81-47  
 Ростов-на-Дону (863)308-18-15  
 Рязань (4912)46-61-64  
 Самара (846)206-03-16  
 Санкт-Петербург (812)309-46-40  
 Саратов (845)249-38-78  
 Севастополь (8692)22-31-93  
 Симферополь (3652)67-13-56  
 Смоленск (4812)29-41-54  
 Сочи (862)225-72-31  
 Ставрополь (8652)20-65-13  
 Таджикистан (992)427-82-92-69

Сургут (3462)77-98-35  
 Тверь (4822)63-31-35  
 Томск (3822)98-41-53  
 Тула (4872)74-02-29  
 Тюмень (3452)66-21-18  
 Ульяновск (8422)24-23-59  
 Уфа (347)229-48-12  
 Хабаровск (4212)92-98-04  
 Челябинск (351)202-03-61  
 Череповец (8202)49-02-64  
 Ярославль (4852)69-52-93

**Pressione d'esercizio***Working Pressures**Betriebsdruck**Pression de service**Presión de Ejercicio**Pressão de Trabalho***0 bar  
12 bar****Max pressione statica (no pulsazioni)***Maximum static pressure (no pulsations)**Maximaler statischer Betriebsdruck (ohne pulsations)**Pression statique maximale (sans pulsation)**Presión estática máxima (sin pulsaciones)**Pressão estática máxima (sem pulsações)***35 bar****Temperature***Temperatures**Temperatur**Températures**Temperaturas**Temperaturas***- 20 °C  
+ 80 °C****Con O-ring in FKM***With FKM O-ring**Mit O-ring in FKM**Avec joints en FKM**Con junta tórica en FKM**Com O-ring em FKM***- 10 °C  
+ 200 °C****Fluidi compatibili***Aria compressa**Fluids**Compressed air**Geeignete Medien**Druckluft**Fluides compatibles**Air comprimé**Fluidos compatibles**Aire comprimido**Fluidos compatíveis**Ar comprimido***Per altri fluidi, consultare l'ufficio tecnico Aignep.***For other fluids, consult the technical department Aignep.**Für andere Flüssigkeiten, kontaktieren Sie uns.**Pour d'autres fluides, veuillez nous consulter.**Para otros fluidos póngase en contacto con el departamento técnico Aignep.**Para outros fluidos consulte o departamento técnico da Aignep.***Portata****NI/min***Flow Rate**Durchflusswerte**Débit**Caudal de Flujo**Vazão*

6 bar Δ 1	6 bar Δ 0.5	6 bar *
285	240	445

*\* Scarico libero - Exhaust Free - Kostenlose Auspuff - Échappement libre - Escape Libre - Descarga libre.***Filettatura****IT***Gas cilindrica conforme ISO 228 Classe A.***Threads****GB***Parallel gas in conformity with ISO 228 Class A.***Gewindearten****DE***Zylindrisches Gewinde nach Norm ISO 228 Classe A.***Filetages****FR***Filetage cylindrique conforme: ISO 228 Classe A.***Roscas****ES***Gas cilíndrica conforme ISO 228 Clase A.***Roscas****PT***Gas paralela conforme ISO 228 Classe A.*

## 181

### PRESA MASCHIO PER INNESTI OTTURATI

MALE SOCKET FOR SHUTTER PLUG  
VERSCHLUSS-KUPPLUNG MIT AUSSENGEWINDE FÜR STECKER ABSPERREND  
COUPLEUR MÂLE AVEC OBTURATION  
ENCHUFE MACHO PARA ADAPTADOR OBTURADO  
SOQUETE COM ROSCA MACHO PARA PLUG COM RETENÇÃO

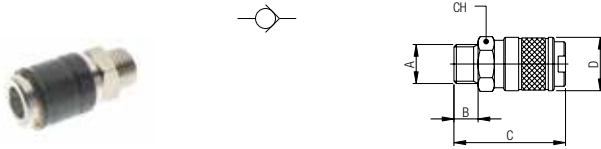

Code	A	B	C	D	CH	Pack.
00181 00 001	1/8	6	35.5	18	16	10
00181 00 002	1/4	8	37.5	18	16	10
00181 00 003	3/8	9	38.5	18	19	10

## 182

### PRESA FEMMINA PER INNESTI OTTURATI

FEMALE SOCKET FOR SHUTTER PLUG  
VERSCHLUSS-KUPPLUNG MIT INNENGEWINDE FÜR STECKER ABSPERREND  
COUPLEUR FEMELLE AVEC OBTURATION  
ENCHUFE HEMBRA PARA ADAPTADOR OBTURADO  
SOQUETE COM ROSCA FÊMEA PARA PLUG COM RETENÇÃO

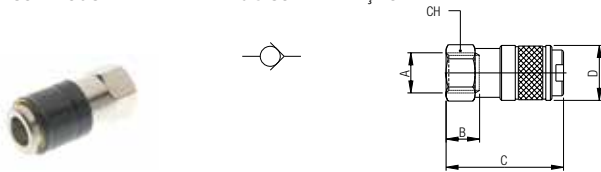

Code	A	B	C	D	CH	Pack.
00182 00 001	1/8	7.5	35	18	16	10
00182 00 002	1/4	11	38.5	18	16	10
00182 00 003	3/8	11.5	39	18	19	10

## 183

### PRESA A CALZAMENTO CON MOLLA PER INNESTI OTTURATI

COMPRESSION SOCKET WITH NUT AND SPRING FOR SHUTTER PLUG  
VERSCHLUSS-KUPPLUNG SCHOTTVERSION MIT KNICKSCHUTZFEDER FÜR STECKER ABSPERREND  
COUPLEUR À COIFFE AVEC OBTURATION  
ENCHUFE TUBO CON MUELLE PARA ADAPTADOR OBTURADO  
SOQUETE COM CONEXÃO PUSH-ON COM MOLA PARA PLUG COM RETENÇÃO

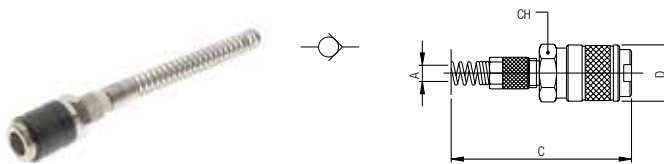

Code	A	C	D	CH	Pack.
00183 00 001	6/4	124	18	16	10
00183 00 002	8/6	129.5	18	16	10

Molla Acciaio Inox AISI 304 - EN 1.4301  
Stainless Steel Spring AISI 304 - EN 1.4301  
Edelstahlfeder AISI 304 - EN 1.4301  
Ressort Acier Inoxydable AISI 304 - EN 1.4301  
Muelle Acero Inoxidable AISI 304 - EN 1.4301  
Mola Aço Inoxidável AISI 304 - EN 1.4301

## 184

### PRESA A CALZAMENTO PER INNESTI OTTURATI

COMPRESSION SOCKET FOR SHUTTER PLUG  
VERSCHLUSS-KUPPLUNG MIT ÜBERWURFVERSCHRAUBUNG FÜR STECKER ABSPERREND  
COUPLEUR À COIFFE AVEC OBTURATION  
ENCHUFE TUBO PARA ADAPTADOR OBTURADO  
SOQUETE COM CONEXÃO PUSH-ON PARA PLUG COM RETENÇÃO

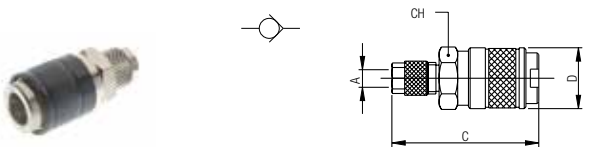

Code	A	C	D	CH	Pack.
00184 00 001	6/4	42	18	16	10
00184 00 002	8/6	42	18	16	10

## 185

### PRESA CON PORTAGOMMA A RESCA PER INNESTI OTTURATI

SOCKET WITH REST FOR RUBBER HOSE FOR SHUTTER PLUG  
VERSCHLUSS-KUPPLUNG MIT SCHLAUCHTÜLLE BEIDSEITIG ABSPERREND  
COUPLEUR À DOUILLE ANNELÉE AVEC OBTURATION  
ENCHUFE ESPIGA PARA ADAPTADOR OBTURADO  
SOQUETE COM ESPIGÃO PARA TUBO DE BORRACHA PARA PLUG COM RETENÇÃO

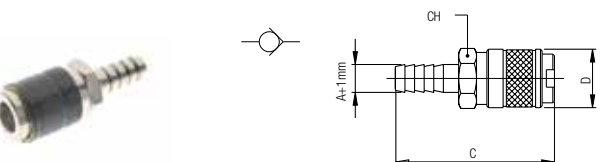

Code	A	C	D	CH	Pack.
00185 00 001	4	48	18	16	10
00185 00 002	6	48	18	16	10
00185 00 003	8	48	18	16	10

## 281

### INNESTO OTTURATO MASCHIO

MALE SHUTTER PLUG

STECKER ABSPERREND MIT AUSSENGEWINDE

EMBOUT MÂLE, DOUBLE OBTURATIONS

ADAPTADOR OBTURADO MACHO

PLUG COM RETENÇÃO E ROSCA MACHO

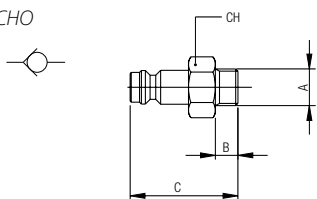

Code	A	B	C	CH	Pack.
00281 00 001	1/8	6	29.5	14	10
00281 00 002	1/4	8	31.5	17	10
00281 00 003	3/8	9	32.5	19	10

Utilizzare solo con prese per innesti otturati.

Using only with socket for shutter plug.

Nur Mit Verschluss-Kupplungen Beidseitig Absperrend Einsetzbar.

Utilisable avec pleurico à obturation.

Utilizar solo con enchufes para adaptador obturado.

Utilizar somente com soquete para plug com retenção.

## 282

### INNESTO OTTURATO FEMMINA

FEMALE SHUTTER PLUG

STECKER ABSPERREND MIT INNENGEWINDE

EMBOUT FEMELLE, DOUBLE OBTURATIONS

ADAPTADOR OBTURADO HEMBRA

PLUG COM RETENÇÃO E ROSCA FÊMEA

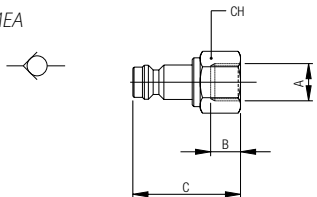

Code	A	B	C	CH	Pack.
00282 00 001	1/8	7.5	31.5	14	10
00282 00 002	1/4	11	35	17	10
00282 00 003	3/8	11.5	35.5	19	10

Utilizzare solo con prese per innesti otturati.

Using only with socket for shutter plug.

Nur Mit Verschluss-Kupplungen Beidseitig Absperrend Einsetzbar.

Utilisable avec pleurico à obturation.

Utilizar solo con enchufes para adaptador obturado.

Utilizar somente com soquete para plug com retenção.

## 283

### INNESTO OTTURATO A CALZAMENTO CON MOLLA

COMPRESSION SHUTTER PLUG WITH NUT AND SPRING

STECKER ABSPERREND MIT KNICKSCHUTZFEDER

EMBOUT AVEC RESSORT DE PROTECTION, DOUBLE OBTURATIONS

ADAPTADOR OBTURADO TUBO CON MUELLE

PLUG COM RETENÇÃO E CONEXÃO PUSH-ON COM MOLA

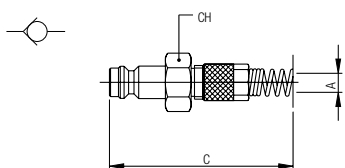

Code	A	C	CH	Pack.
00283 00 001	6/4	118.5	12	10
00283 00 002	8/6	122	12	10

Utilizzare solo con prese per innesti otturati.

Using only with socket for shutter plug.

Nur Mit Verschluss-Kupplungen Beidseitig Absperrend Einsetzbar.

Utilisable avec pleurico à obturation.

Utilizar solo con enchufes para adaptador obturado.

Utilizar somente com soquete para plug com retenção.

Molla Acciaio Inox AISI 304 - EN 1.4301  
 Stainless Steel Spring AISI 304 - EN 1.4301  
 Edelstahlfeder AISI 304 - EN 1.4301  
 Ressort Acier Inoxydable AISI 304 - EN 1.4301  
 Muelle Acero Inoxidable AISI 304 - EN 1.4301  
 Mola Aço Inoxidável AISI 304 - EN 1.4301

## 284

### INNESTO OTTURATO A CALZAMENTO

COMPRESSION SHUTTER PLUG

STECKER ABSPERREND MIT ÜBERWURFVERSCHRAUBUNG

EMBOUT À RACCORD À COIFFE, DOUBLE OBTURATION

ADAPTADOR OBTURADO TUBO

PLUG COM RETENÇÃO E CONEXÃO PUSH-ON

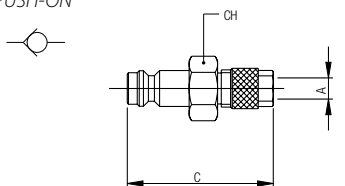

Code	A	C	CH	Pack.
00284 00 001	6/4	36.5	12	10
00284 00 002	8/6	36.5	12	10

Utilizzare solo con prese per innesti otturati.

Using only with socket for shutter plug.

Nur Mit Verschluss-Kupplungen Beidseitig Absperrend Einsetzbar.

Utilisable avec pleurico à obturation.

Utilizar solo con enchufes para adaptador obturado.

Utilizar somente com soquete para plug com retenção.

## 285

### INNESTO OTTURATO PORTAGOMMA A RESCA

SHUTTER PLUG WITH REST FOR RUBBER HOSE

STECKER ABSPERREND MIT SCHLAUCHTÜLLE

EMBOUT À DOUILLE ANNELEE, DOUBLE OBTURATIONS

ADAPTADOR OBTURADO ESPIGA

PLUG COM RETENÇÃO E ESPIGÃO PARA TUBO DE BORRACHA

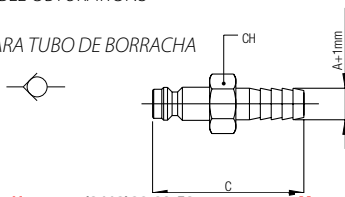

Code	A	C	CH	Pack.
00285 00 001	4	43.5	11	10
00285 00 002	6	43.5	11	10
00285 00 003	8	43.5	13	10

Utilizzare solo con prese per innesti otturati.

Using only with socket for shutter plug.

Nur Mit Verschluss-Kupplungen Beidseitig Absperrend Einsetzbar.

Utilisable avec pleurico à obturation.

Utilizar solo con enchufes para adaptador obturado.

Utilizar somente com soquete para plug com retenção.

Архангельск (8182)63-90-72  
 Астана (7172)727-132  
 Астрахань (8512)99-46-04  
 Барнаул (3852)73-04-60  
 Белгород (4722)40-23-64  
 Брянск (4832)59-03-52  
 Владивосток (423)249-28-31  
 Волгоград (844)278-03-48  
 Вологда (8172)26-41-59  
 Воронеж (473)204-51-73  
 Екатеринбург (343)384-55-89  
 Иваново (4932)77-34-06

Ижевск (3412)26-03-58  
 Иркутск (395)279-98-46  
 Казань (843)206-01-48  
 Калининград (4012)72-03-81  
 Калуга (4842)92-23-67  
 Кемерово (3842)65-04-62  
 Киров (8332)68-02-04  
 Краснодар (861)203-40-90  
 Красноярск (391)204-63-61  
 Курск (4712)77-13-04  
 Липецк (4742)52-20-81  
 Киргизия (996)312-96-26-47

Магнитогорск (3519)55-03-13  
 Москва (495)268-04-70  
 Мурманск (8152)59-64-93  
 Набережные Челны (8552)20-53-41  
 Нижний Новгород (831)429-08-12  
 Новокузнецк (3843)20-46-81  
 Новосибирск (383)227-86-73  
 Омск (3812)21-46-40  
 Орел (4862)44-53-42  
 Оренбург (3532)37-68-04  
 Пенза (8412)22-31-16  
 Казахстан (772)734-952-31

Пермь (342)205-81-47  
 Ростов-на-Дону (863)308-18-15  
 Рязань (4912)46-61-64  
 Самара (846)206-03-16  
 Санкт-Петербург (812)309-46-40  
 Саратов (845)249-38-78  
 Севастополь (8692)22-31-93  
 Уфа (347)229-48-12  
 Симферополь (3652)67-13-56  
 Смоленск (4812)29-41-54  
 Сочи (862)225-72-31  
 Ставрополь (8652)20-65-13  
 Таджикистан (992)427-82-92-69

Сургут (3462)77-98-35  
 Тверь (4822)63-31-35  
 Томск (3822)98-41-53  
 Тула (4872)74-02-29  
 Тюмень (3452)66-21-18  
 Ульяновск (8422)24-23-59  
 Уфа (347)229-48-12  
 Хабаровск (4212)92-98-04  
 Челябинск (351)202-03-61  
 Череповец (8202)49-02-64  
 Ярославль (4852)69-52-93