



**CARATTERISTICHE TECNICHE**  
 TECHNICAL CHARACTERISTICS  
 TECHNISCHE ANGABEN  
 CARACTÉRISTIQUES TECHNIQUES  
 CARACTERÍSTICAS TÉCNICAS  
 CARACTERÍSTICAS TÉCNICAS



**Norma di Riferimento**

Reference standard

Entspricht der Norm

Norme de référence

Normativa de referencia

Norma de referència

1907/2006  
 REACH ✓

2011/65/CE  
 RoHS ✓

PED  
 2014/68/UE

SILICON  
 FREE

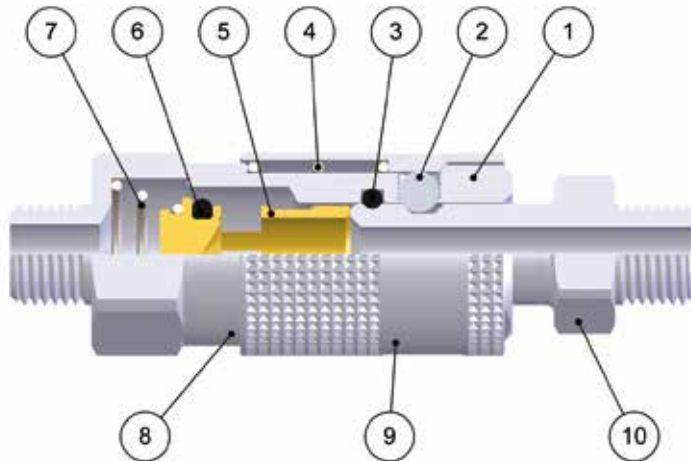

DN  
 2.7 mm

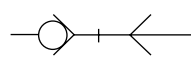

**FKM A RICHIESTA**  
 IF REQUESTED FKM  
 FKM AUF ANFRAGE  
 FKM SUR DEMANDE  
 FKM BAJO DEMANDA  
 FKM SOB ENCOMENDA

Materiali e Componenti	IT	Component Parts and Materials	GB	Komponenten und Materialien	DE
1 Corpo in Ottone Nichelato		1 Nickel-Plated Brass Body		1 Körper Messing Vernickelt	
2 Sfera in Acciaio AISI 420		2 Stainless Steel AISI 420 Balls		2 Kugel Edelstahl AISI 420	
3 Guarnizione O-Ring in NBR		3 NBR O-Ring Seals		3 O-Ring NBR	
4 Molla Ghiera in Acciaio AISI 302		4 Stainless Steel AISI 302 Ring Nut Spring		4 Entriegelungsfeder Edelstahl AISI 302	
5 Otturatore in Ottone		5 Brass Shutter		5 Verschluss Messing	
6 Guarnizione O-Ring in NBR		6 NBR O-Ring Seals		6 O-Ring NBR	
7 Molla Otturatore in Acciaio AISI 302		7 Stainless Steel AISI 302 Shutter Spring		7 Verschlussfeder Edelstahl AISI 302	
8 Attacco Terminale in Ottone Nichelato		8 Nickel-Plated Brass Coupling Back Part		8 Einschraubkörper Messing Vernickelt	
9 Ghiera in Ottone Nichelato		9 Nickel-Plated Brass Sleeve		9 Entriegelungshülse Messing Vernickelt	
10 Innesto in Ottone Nichelato		10 Nickel-Plated Brass Plug Outline		10 Stecker Messing Vernickelt	

Matériaux et Composants	FR	Materiales y Componentes	ES	Materiais e Componentes	PT
1 Corps: Laiton Nickelé		1 Cuerpo en latón niquelado		1 Corpo em latão niquelado	
2 Bille: Acier Inoxydable AISI 420		2 Esfera en acero AISI 420		2 Esfera em aço AISI 420	
3 Joint Torique en NBR		3 Junta tórica en NBR		3 Vedação O-Ring em NBR	
4 Ressort de Bague: Acier Inoxydable AISI 302		4 Muelle tuerca en acero AISI 302		4 Mola de porca em aço AISI 302	
5 Clapet: Laiton		5 Obturador en latón		5 Obturador em latão	
6 Joint Torique en NBR		6 Junta tórica en NBR		6 Vedação O-Ring em NBR	
7 Ressort de Clapet: Acier Inoxydable AISI 302		7 Muelle obturador en acero AISI 302		7 Mola do obturador em aço AISI 302	
8 Corps: Laiton Nickelé		8 Conexión terminal en latón niquelado		8 Conexão terminal em latão niquelado	
9 Bague: Laiton Nickelé		9 Tuerca en latón niquelado		9 Porca em latão niquelado	
10 Embout: Laiton Nickelé		10 Enchufe en latón niquelado		10 Plug em latão niquelado	

Архангельск (8182)63-90-72  
 Астана (7172)727-132  
 Астрахань (8512)99-46-04  
 Барнаул (3852)73-04-60  
 Белгород (4722)40-23-64  
 Брянск (4832)59-03-52  
 Владивосток (423)249-28-31  
 Волгоград (844)278-03-48  
 Вологда (8172)26-41-59  
 Воронеж (473)204-51-73  
 Екатеринбург (343)384-55-89  
 Иваново (4932)77-34-06

Ижевск (3412)26-03-58  
 Иркутск (395)279-98-46  
 Казань (843)206-01-48  
 Калининград (4012)72-03-81  
 Калуга (4842)92-23-67  
 Кемерово (3842)65-04-62  
 Киров (8332)68-02-04  
 Краснодар (861)203-40-90  
 Красноярск (391)204-63-61  
 Курск (4712)77-13-04  
 Липецк (4742)52-20-81  
 Киргизия (996)312-96-26-47

Магнитогорск (3519)55-03-13  
 Москва (495)268-04-70  
 Мурманск (8152)59-64-93  
 Набережные Челны (8552)20-53-41  
 Нижний Новгород (831)429-08-12  
 Новокузнецк (3843)20-46-81  
 Новосибирск (383)227-86-73  
 Омск (3812)21-46-40  
 Орел (4862)44-53-42  
 Оренбург (3532)37-68-04  
 Пенза (8412)22-31-16  
 Казахстан (772)734-952-31

Пермь (342)205-81-47  
 Ростов-на-Дону (863)308-18-15  
 Рязань (4912)46-61-64  
 Самара (846)206-03-16  
 Санкт-Петербург (812)309-46-40  
 Саратов (845)249-38-78  
 Севастополь (8692)22-31-93  
 Симферополь (3652)67-13-56  
 Смоленск (4812)29-41-54  
 Сочи (862)225-72-31  
 Ставрополь (8652)20-65-13  
 Таджикистан (992)427-82-92-69

Сургут (3462)77-98-35  
 Тверь (4822)63-31-35  
 Томск (3822)98-41-53  
 Тула (4872)74-02-29  
 Тюмень (3452)66-21-18  
 Ульяновск (8422)24-23-59  
 Уфа (347)229-48-12  
 Хабаровск (4212)92-98-04  
 Челябинск (351)202-03-61  
 Череповец (8202)49-02-64  
 Ярославль (4852)69-52-93

**Pressione d'esercizio***Working Pressures**Betriebsdruck**Pression de service**Presión de Ejercicio**Pressão de Trabalho***0 bar**  
**12 bar****Max pressione statica (no pulsazioni)***Maximum static pressure (no pulsations)**Maximaler statischer Betriebsdruck (ohne pulsations)**Pression statique maximale (sans pulsation)**Presión estática máxima (sin pulsaciones)**Pressão estática máxima (sem pulsações)***35 bar****Temperature***Temperatures**Temperatur**Températures**Temperaturas**Temperaturas***- 20 °C**  
**+ 80 °C***Con O-ring in FKM**With FKM O-ring**Mit O-ring in FKM**Avec joints en FKM**Con junta tórica en FKM**Com O-ring em FKM***- 10 °C**  
**+ 200 °C****Fluidi compatibili***Aria compressa**Fluids**Compressed air**Geeignete Medien**Druckluft**Fluides compatibles**Air comprimé**Fluidos compatibles**Aire comprimido**Fluidos compatíveis**Ar comprimido***Per altri fluidi, consultare l'ufficio tecnico Aignep.***For other fluids, consult the technical department Aignep.**Für andere Flüssigkeiten, kontaktieren Sie uns.**Pour d'autres fluides, veuillez nous consulter.**Para otros fluidos póngase en contacto con el departamento técnico Aignep.**Para outros fluidos consulte o departamento técnico da Aignep.***Portata****NI/min***Flow Rate**Durchflusswerte**Débit**Caudal de Flujo**Vazão*

6 bar Δ 1	6 bar Δ 0.5	6 bar *
235	175	295

*\* Scarico libero - Exhaust Free - Kostenlose Auspuff - Échappement libre - Escape Libre - Descarga livre.***Filettatura****IT****Threads****GB****Gewindearten****DE***Gas cilindrica conforme ISO 228 Classe A.**Parallel gas in conformity with ISO 228 Class A.**Zylindrisches Gewinde nach Norm ISO 228 Classe A.***Filetages****FR****Roscas****ES****Roscas****PT***Filetage cylindrique conforme: ISO 228 Class A.**Gas cilíndrica conforme ISO 228 Clase A.**Gas paralela conforme ISO 228 Classe A.***701****PRESA MASCHIO***MALE SOCKET**VERSCHLUSS-KUPPLUNG MIT AUSSENGEWINDE**COUPLEUR MÂLE**ENCHUFE MACHO**SOQUETE COM ROSCA MACHO*

Code	A	B	C	D	CH1	Pack.
00701 00 001	M5	4	25	10	9	10
00701 00 002	1/8	6	26,5	10	11	10

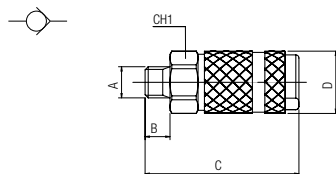

## 702

### PRESA FEMMINA

FEMALE SOCKET

VERSCHLUSS-KUPPLUNG MIT INNENGEWINDE

COUPLEUR FEMELLE

ENCHUFE HEMBRA

SOQUETE COM ROSCA FÊMEA

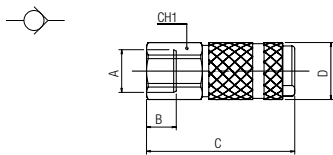

Code	A	B	C	D	CH1	Pack.
00702 00 001	M5	5.5	26	10	9	10
00702 00 002	1/8	7.5	28	10	12	10

## 704

### PRESA A CALZAMENTO

COMPRESSION SOCKET

VERSCHLUSS-KUPPLUNG MIT ÜBERWURFVERSCHRAUBUNG

COUPLEUR RACCORD À COIFFE

ENCHUFE TUBO

SOQUETE COM CONEXÃO PUSH-ON

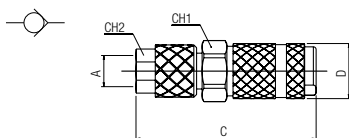

Code	A	C	D	CH1	CH2	Pack.
00704 00 001	4/2.7	31.5	10	9	7	10
00704 00 002	6/4	32.5	10	10	8	10

## 801

### INNESTO MASCHIO

MALE PLUG

STECKER MIT AUSSENGEWINDE

EMBOUT MÂLE

ADAPTADOR MACHO

PLUG COM ROSCA MACHO

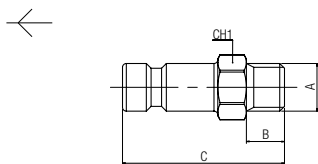

Code	A	B	C	CH1	Pack.
00801 00 01 B5 NB	M5	4	17	7	10
00801 00 01 02 NB	1/8	6	19	11	10

## 802

### INNESTO FEMMINA

FEMALE PLUG

STECKER MIT INNENGEWINDE

EMBOUT FEMELLE

ADAPTADOR HEMBRA

PLUG COM ROSCA FÊMEA

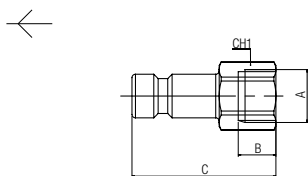

Code	A	B	C	CH1	Pack.
00802 00 01 B5 NB	M5	5.5	16.5	7	10
00802 00 01 02 NB	1/8	7.5	18.5	12	10

## 804

### INNESTO A CALZAMENTO

COMPRESSION PLUG

STECKER MIT ÜBERWURFVERSCHRAUBUNG

EMBOUT À RACCORD À COIFFE

ADAPTADOR TUBO

PLUG COM CONEXÃO PUSH-ON

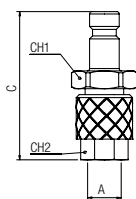

Code	A	C	CH1	CH2	Pack.
00804 00 001	4/2.7	24	7	7	10
00804 00 002	6/4	25	10	8	10

Архангельск (8182)63-90-72  
 Астана (7172)727-132  
 Астрахань (8512)99-46-04  
 Барнаул (3852)73-04-60  
 Белгород (4722)40-23-64  
 Брянск (4832)59-03-52  
 Владивосток (423)249-28-31  
 Волгоград (844)278-03-48  
 Вологда (8172)26-41-59  
 Воронеж (473)204-51-73  
 Екатеринбург (343)384-55-89  
 Иваново (4932)77-34-06

Ижевск (3412)26-03-58  
 Иркутск (395)279-98-46  
 Казань (843)206-01-48  
 Калининград (4012)72-03-81  
 Калуга (4842)92-23-67  
 Кемерово (3842)65-04-62  
 Киров (8332)68-02-04  
 Краснодар (861)203-40-90  
 Красноярск (391)204-63-61  
 Курск (4712)77-13-04  
 Липецк (4742)52-20-81  
 Киргизия (996)312-96-26-47

Магнитогорск (3519)55-03-13  
 Москва (495)268-04-70  
 Мурманск (8152)59-64-93  
 Набережные Челны (8552)20-53-41  
 Нижний Новгород (831)429-08-12  
 Новокузнецк (3843)20-46-81  
 Новосибирск (383)227-86-73  
 Омск (3812)21-46-40  
 Новокузнецк (3843)20-46-81  
 Новосибирск (383)227-86-73  
 Омск (3812)21-46-40  
 Оренбург (3532)37-68-04  
 Орел (4862)44-53-42  
 Оренбург (3532)37-68-04  
 Пенза (8412)22-31-16  
 Казахстан (772)734-952-31

Пермь (342)205-81-47  
 Ростов-на-Дону (863)308-18-15  
 Рязань (4912)46-61-64  
 Самара (846)206-03-16  
 Санкт-Петербург (812)309-46-40  
 Саратов (845)249-38-78  
 Севастополь (8692)22-31-93  
 Симферополь (3652)67-13-56  
 Смоленск (4812)29-41-54  
 Сочи (862)225-72-31  
 Ставрополь (8652)20-65-13  
 Таджикистан (992)427-82-92-69

Сургут (3462)77-98-35  
 Тверь (4822)63-31-35  
 Томск (3822)98-41-53  
 Тула (4872)74-02-29  
 Тюмень (3452)66-21-18  
 Ульяновск (8422)24-23-59  
 Уфа (347)229-48-12  
 Хабаровск (4212)92-98-04  
 Челябинск (351)202-03-61  
 Череповец (8202)49-02-64  
 Ярославль (4852)69-52-93