



**CARATTERISTICHE TECNICHE**  
 TECHNICAL CHARACTERISTICS  
 TECHNISCHE ANGABEN  
 CARACTÉRISTIQUES TECHNIQUES  
 CARACTERÍSTICAS TÉCNICAS  
 CARACTERÍSTICAS TÉCNICAS



**Norma di Riferimento**  
 Reference standard  
 Entspricht der Norm  
 Norme de référence  
 Normativa de referencia  
 Norma de referència

1907/2006 <b>REACH</b> ✓	2011/65/CE ✓ <b>RoHS</b>
PED 2014/68/UE	SILICON FREE

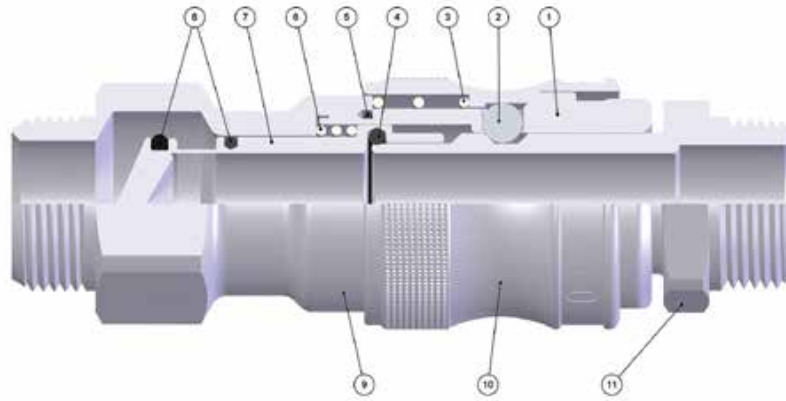

**FKM A RICHIESTA**  
 IF REQUESTED FKM  
 FKM AUF ANFRAGE  
 FKM SUR DEMANDE  
 FKM BAJO DEMANDA  
 FKM SOB ENCOMENDA

DN  
12 mm

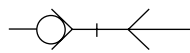

UNI ISO 6150-B17

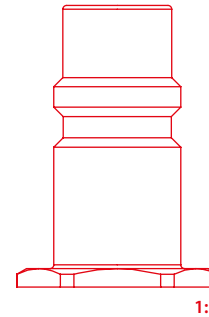

Materiali e Componenti	IT	Component Parts and Materials	GB	Komponenten und Materialien	DE
1 Corpo in Ottone Nichelato		1 Nickel-Plated Brass Body		1 Körper Messing Vernickelt	
2 Sfera in Acciaio AISI 420		2 Stainless Steel AISI 420 Balls		2 Kugel Edelstahl AISI 420	
3 Molla Ghiera in Acciaio AISI 302		3 Stainless Steel AISI 302 Ring Nut Spring		3 Ntringelungsfeder Edelstahl AISI 302	
4 Guarnizione O-Ring in NBR		4 NBR O-Ring Seals		4 O-Ring NBR	
5 Guarnizione O-Ring in NBR		5 NBR O-Ring Seals		5 O-Ring NBR	
6 Molla Otturatore in Acciaio AISI 302		6 Stainless Steel AISI 302 Shutter Spring		6 Verschlussfeder Edelstahl AISI 302	
7 Otturatore in Ottone Nichelato		7 Nickel-Plated Brass Shutter		7 Verschluss Messing Vernickelt	
8 Guarnizione O-Ring in NBR		8 NBR O-Ring Seals		8 O-Ring NBR	
9 Attacco Terminale in Ottone Nichelato		9 Nickel-Plated Brass Coupling Back Part		9 Einschraubkörper Messing Vernickelt	
10 Ghiera in Ottone Nichelato		10 Nickel-Plated Brass Sleeve		10 Entriegelungshülse Messing Vernickelt	
11 Innesto in Ottone Nichelato		11 Nickel-Plated Brass Plug Outline		11 Stecker Messing Vernickelt	

Matériaux et Composants	FR	Materiales y Componentes	ES	Materialis e Componentes	PT
1 Corps: Laiton Nickelé		1 Cuerpo en latón niquelado		1 Corpo em latão niquelado	
2 Bille: Acier Inoxydable AISI 420		2 Esfera en acero AISI 420		2 Esfera em aço AISI 420	
3 Ressort de Bague: Acier Inoxydable AISI 302		3 Muelle tuerca en acero AISI 302		3 Mola de porca em aço AISI 302	
4 Joint Torique en NBR		4 Junta tórica en NBR		4 Vedação O-Ring em NBR	
5 Joint Torique en NBR		5 Junta tórica en NBR		5 Vedação O-Ring em NBR	
6 Ressort de Clapet: Acier Inoxydable AISI 302		6 Muelle obturador en acero AISI 302		6 Mola do obturador em aço AISI 302	
7 Clapet en Laiton Nickelé		7 Obturador en latón niquelado		7 Obturador em latão niquelado	
8 Joint Torique en NBR		8 Junta tórica en NBR		8 Vedação O-Ring em NBR	
9 Corps: Laiton Nickelé		9 Conexión terminal en latón niquelado		9 Conexão terminal em latão niquelado	
10 Bague: Laiton Nickelé		10 Tuerca en latón niquelado		10 Porca em latão niquelado	
11 Embout: Laiton Nickelé		11 Enchufe en latón niquelado		11 Plug em latão niquelado	

Архангельск (8182)63-90-72  
 Астана (7172)727-132  
 Астрахань (8512)99-46-04  
 Барнаул (3852)73-04-60  
 Белгород (4722)40-23-64  
 Брянск (4832)59-03-52  
 Владивосток (423)249-28-31  
 Волгоград (844)278-03-48  
 Вологда (8172)26-41-59  
 Воронеж (473)204-51-73  
 Екатеринбург (343)384-55-89  
 Иваново (4932)77-34-06

Ижевск (3412)26-03-58  
 Иркутск (395)279-98-46  
 Казань (843)206-01-48  
 Калининград (4012)72-03-81  
 Калуга (4842)92-23-67  
 Кемерово (3842)65-04-62  
 Киров (8332)68-02-04  
 Краснодар (861)203-40-90  
 Красноярск (391)204-63-61  
 Курск (4712)77-13-04  
 Липецк (4742)52-20-81  
 Киргизия (996)312-96-26-47

Магнитогорск (3519)55-03-13  
 Москва (495)268-04-70  
 Мурманск (8152)59-64-93  
 Нижерейные Челны (8552)20-53-41  
 Нижний Новгород (831)429-08-12  
 Новокузнецк (8343)20-46-81  
 Новосибирск (383)227-86-73  
 Омск (3812)21-46-40  
 Орел (4862)44-53-42  
 Оренбург (3532)37-68-04  
 Пенза (8412)22-31-16  
 Казахстан (772)734-952-31

Пермь (342)205-81-47  
 Ростов-на-Дону (863)308-18-15  
 Рязань (4912)46-61-64  
 Самара (846)206-03-16  
 Санкт-Петербург (812)309-46-40  
 Саратов (845)249-38-78  
 Севастополь (8692)22-31-93  
 Симферополь (3652)67-13-56  
 Смоленск (4812)29-41-54  
 Сочи (862)225-72-31  
 Ставрополь (8652)20-65-13  
 Таджикистан (992)427-82-92-69

Сургут (3462)77-98-35  
 Тверь (4822)63-31-35  
 Томск (3822)98-41-53  
 Тула (4872)74-02-29  
 Тюмень (3452)66-21-18  
 Ульяновск (8422)24-23-59  
 Уфа (347)229-48-12  
 Хабаровск (4212)92-98-04  
 Челябинск (351)202-03-61  
 Череповец (8202)49-02-64  
 Ярославль (4852)69-52-93

**Pressione d'esercizio***Working Pressures**Betriebsdruck**Pression de service**Presión de Ejercicio**Pressão de Trabalho***0 bar****16 bar****Max pressione statica (no pulsazioni)***Maximum static pressure (no pulsations)**Maximaler statischer Betriebsdruck (ohne pulsations)**Pression statique maximale (sans pulsation)**Presión estática máxima (sin pulsaciones)**Pressão estática máxima (sem pulsações)***35 bar****Temperature***Temperatures**Temperatur**Températures**Temperaturas**Temperaturas***- 20 °C****+ 80 °C***Con O-ring in FKM**With FKM O-ring**Mit O-ring in FKM**Avec joints en FKM**Con junta tórica en FKM**Com O-ring em FKM***- 10 °C****+ 200 °C****Fluidi compatibili***Aria compressa**Fluids**Compressed air**Geeignete Medien**Druckluft**Fluides compatibles**Air comprimé**Fluidos compatibles**Aire comprimido**Fluidos compatíveis**Ar comprimido***Per altri fluidi, consultare l'ufficio tecnico Aignep.***For other fluids, consult the technical department Aignep.**Für andere Flüssigkeiten, kontaktieren Sie uns.**Pour d'autres fluides, veuillez nous consulter.**Para otros fluidos póngase en contacto con el departamento técnico Aignep.**Para outros fluidos consulte o departamento técnico da Aignep.***Portata****NI/min***Flow Rate**Durchflusswerte**Débit**Caudal de Flujo**Vazão***6 bar****Δ 1**

4200

**6 bar****Δ 0.5**

3200

**6 bar****\***

4750

*\* Scarico libero - Exhaust Free - Kostenlose Auspuff - Échappement libre - Escape Libre - Descarga livre.***Filettatura****IT****Threads****GB****Gewindearten****DE***Gas cilindrica conforme ISO 228 Classe A.**Parallel gas in conformity with ISO 228 Class A.**Zylindrisches Gewinde nach Norm ISO 228 Classe A.***Filetages****FR****Roscas****ES****Roscas****PT***Filetage cylindrique conforme: ISO 228 Class A.**Gas cilíndrica conforme ISO 228 Clase A.**Gas paralela conforme ISO 228 Classe A.*

# 711

## PRESA MASCHIO

MALE SOCKET

VERSCHLUSS-KUPPLUNG MIT AUSSENGEWINDE

COUPLEUR MÂLE

ENCHUFE MACHO

SOQUETE COM ROSCA MACHO

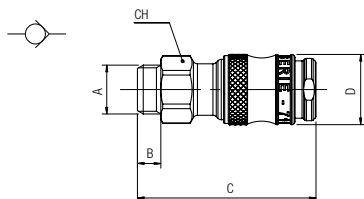

Code	A	B	C	D	CH	Pack.
00711 00 003	1/2	76	10	30	26	10
00711 00 004	3/4	78	12	30	30	10

# 712

## PRESA FEMMINA

FEMALE SOCKET

VERSCHLUSS-KUPPLUNG MIT INNENGEWINDE

COUPLEUR FEMELLE

ENCHUFE HEMBRA

SOQUETE COM ROSCA FÊMEA

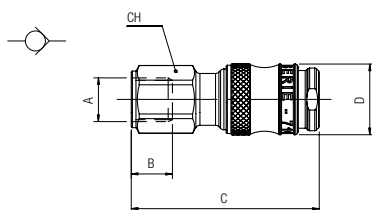

Code	A	B	C	D	CH	Pack.
00712 00 003	1/2	80	15	30	26	10
00712 00 004	3/4	80	16.5	30	30	10

# 811

## INNESTO MASCHIO

MALE PLUG

STECCKER MIT AUSSENGEWINDE

EMBOUT MÂLE

ADAPTADOR MACHO

PLUG COM ROSCA MACHO

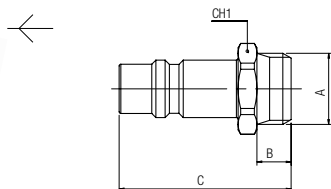

Code	A	B	C	CH1	Pack.
00811 00 01 05 NB	1/2	10	50.5	24	10
00811 00 01 07 NB	3/4	12	52.5	30	10

# 812

## INNESTO FEMMINA

FEMALE PLUG

STECCKER MIT INNENGEWINDE

EMBOUT FEMELLE

ADAPTADOR HEMBRA

PLUG COM ROSCA FÊMEA

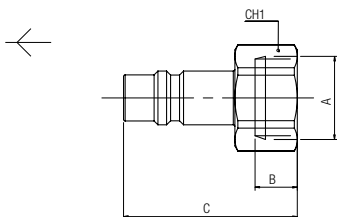

Code	A	B	C	CH1	Pack.
00812 00 01 05 NB	1/2	15	53	24	10
00812 00 01 07 NB	3/4	16.5	54.5	30	10

Архангельск (8182)63-90-72  
 Астана (7172)727-132  
 Астрахань (8512)99-46-04  
 Барнаул (3852)73-04-60  
 Белгород (4722)40-23-64  
 Брянск (4832)59-03-52  
 Владивосток (423)249-28-31  
 Волгоград (844)278-03-48  
 Вологда (8172)26-41-59  
 Воронеж (473)204-51-73  
 Екатеринбург (343)384-55-89  
 Иваново (4932)77-34-06

Ижевск (3412)26-03-58  
 Иркутск (395)279-98-46  
 Казань (843)206-01-48  
 Калининград (4012)72-03-81  
 Калуга (4842)92-23-67  
 Кемерово (3842)65-04-62  
 Киров (8332)68-02-04  
 Краснодар (861)203-40-90  
 Красноярск (391)204-63-61  
 Курск (4712)77-13-04  
 Липецк (4742)52-20-81  
 Киргизия (996)312-96-26-47

Магнитогорск (3519)55-03-13  
 Москва (495)268-04-70  
 Мурманск (8152)59-64-93  
 Набережные Челны (8552)20-53-41  
 Нижний Новгород (831)429-08-12  
 Новокузнецк (3843)20-46-81  
 Новосибирск (383)227-86-73  
 Омск (3812)21-46-40  
 Орел (4862)44-53-42  
 Оренбург (3532)37-68-04  
 Пенза (8412)22-31-16  
 Казахстан (772)734-952-31

Пермь (342)205-81-47  
 Ростов-на-Дону (863)308-18-15  
 Рязань (4912)46-61-64  
 Самара (846)206-03-16  
 Санкт-Петербург (812)309-46-40  
 Саратов (845)249-38-78  
 Севастополь (8692)22-31-93  
 Симферополь (3652)67-13-56  
 Смоленск (4812)29-41-54  
 Сочи (862)225-72-31  
 Ставрополь (8652)20-65-13  
 Таджикистан (992)427-82-92-69

Сургут (3462)77-98-35  
 Тверь (4822)63-31-35  
 Томск (3822)98-41-53  
 Тула (4872)74-02-29  
 Тюмень (3452)66-21-18  
 Ульяновск (8422)24-23-59  
 Уфа (347)229-48-12  
 Хабаровск (4212)92-98-04  
 Челябинск (351)202-03-61  
 Череповец (8202)49-02-64  
 Ярославль (4852)69-52-93