



CARATTERISTICHE TECNICHE
 TECHNICAL CHARACTERISTICS
 TECHNISCHE ANGABEN
 CARACTÉRISTIQUES TECHNIQUES
 CARACTERÍSTICAS TÉCNICAS
 CARACTERÍSTICAS TÉCNICAS



Norma di Riferimento

Reference standard

Entspricht der Norm

Norme de référence

Normativa de referencia

Norma de referência

1907/2006
REACH ✓

2011/65/CE
RoHS ✓

PED
 2014/68/UE

SILICON
 FREE

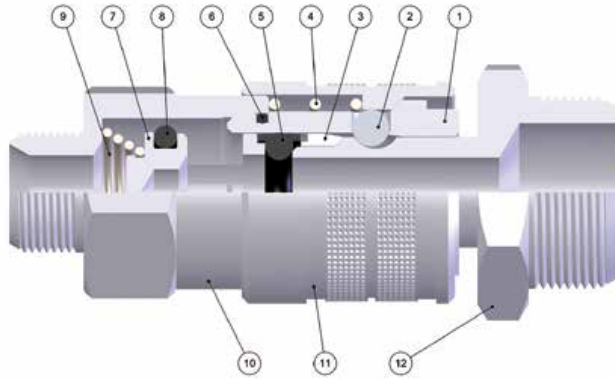

FKM A RICHIESTA
 IF REQUESTED FKM
 FKM AUF ANFRAGE
 FKM SUR DEMANDE
 FKM BAJO DEMANDA
 FKM SOB ENCOMENDA

DN
 7.5 - 7.8 mm

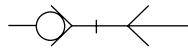

EUROPEAN

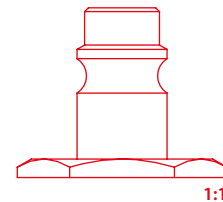

Materiali e Componenti

IT

- 1 Corpo in Ottone Nichelato
- 2 Sfera in Acciaio AISI 420
- 3 Anello Guida Innesto in Ottone Nichelato
- 4 Molla Ghiera in Acciaio AISI 302
- 5 Guarnizione Innesto Sagomata in NBR
- 6 Guarnizione O-Ring in NBR
- 7 Otturatore in Ottone Nichelato
- 8 Guarnizione O-Ring in NBR
- 9 Molla Otturatore in Acciaio AISI 302
- 10 Attacco Terminale in Ottone Nichelato
- 11 Ghiera in Ottone Nichelato
- 12 Innesto in Ottone Nichelato

Component Parts and Materials

GB

- 1 Nickel-Plated Brass Body
- 2 Stainless Steel AISI 420 Balls
- 3 Nickel-Plated Brass Guide Ring Coupling
- 4 Stainless Steel AISI 302 Ring Nut Spring
- 5 NBR Plug Molded Seals
- 6 NBR O-Ring Seals
- 7 Nickel-Plated Brass Shutter
- 8 NBR O-Ring Seals
- 9 Stainless Steel AISI 302 Shutter Spring
- 10 Nickel-Plated Brass Coupling Back Part
- 11 Nickel-Plated Brass Sleeve
- 12 Nickel-Plated Brass Plug Outline

Komponenten und Materialien

DE

- 1 Körper Messing Vernickelt
- 2 Kugel Edelstahl AISI 420
- 3 Stecker Führungsring Messing Vernickelt
- 4 Entriegelungsfeder Edelstahl AISI 302
- 5 O-Ring NBR
- 6 O-Ring NBR
- 7 Verschluss Messing Vernickelt
- 8 O-Ring NBR
- 9 Verschlussfeder Edelstahl AISI 302
- 10 Einschraubkörper Messing Vernickelt
- 11 Entriegelungshülse Messing Vernickelt
- 12 Stecker Messing Vernickelt

Matériaux et Composants

FR

- 1 Corps: Laiton Nickelé
- 2 Bille: Acier Inoxydable AISI 420
- 3 Bague de Guidage: Laiton Nickelé
- 4 Ressort de Bague: Acier Inoxydable AISI 302
- 5 Joint Torique en NBR
- 6 Joint Torique en NBR
- 7 Clapet: Laiton Nickelé
- 8 Joint Torique en NBR
- 9 Ressort de Clapet: Acier Inoxydable AISI 302
- 10 Corps: Laiton Nickelé
- 11 Bague: Laiton Nickelé
- 12 Embout: Laiton Nickelé

Materiales y Componentes

ES

- 1 Cuerpo en latón niquelado
- 2 Esfera en acero AISI 420
- 3 Anillo guía enchufe en latón niquelado
- 4 Muelle tuerca en acero AISI 302
- 5 Tapón obturador sagomata NBR
- 6 Junta tórica en NBR
- 7 Obturador en latón niquelado
- 8 Junta tórica en NBR
- 9 Muelle obturador en acero AISI 302
- 10 Terminal de conexión en latón niquelado
- 11 Tuerca en latón niquelado
- 12 Enchufe en latón niquelado

Materiais e Componentes

PT

- 1 Corpo em Latão Niquelado
- 2 Esfera em aço AISI 420
- 3 Anel guia do plug em latão niquelado
- 4 Mola da porca em aço AISI 302
- 5 Vedações em NBR moldada para plug
- 6 Vedação O-Ring em NBR
- 7 Obturador em latão niquelado
- 8 Vedação O-Ring em NBR
- 9 Mola do obturador em aço AISI 302
- 10 Conexão terminal em latão niquelado
- 11 Porca em latão niquelado
- 12 Plug em latão niquelado

Архангельск (8182)63-90-72
Астана (7172)727-132
Астрахань (8512)99-46-04
Барнаул (3852)73-04-60
Белгород (4722)40-23-64
Брянск (4832)59-03-52
Владивосток (423)249-28-31
Волгоград (844)278-03-48
Вологда (8172)26-41-59
Воронеж (473)204-51-73
Екатеринбург (343)384-55-89
Иваново (4932)77-34-06

Ижевск (3412)26-03-58
Иркутск (395)279-98-46
Казань (843)206-01-48
Калининград (4012)72-03-81
Калуга (4842)92-23-67
Кемерово (3842)65-04-62
Киров (8332)68-02-04
Краснодар (861)203-40-90
Красноярск (391)204-63-61
Курск (4712)77-13-04
Липецк (4742)52-20-81
Киргизия (996)312-96-26-47

Магнитогорск (3519)55-03-13
Москва (495)268-04-70
Мурманск (8152)59-64-93
Набережные Челны (8552)20-53-41
Нижегород (831)429-08-12
Новокузнецк (3843)20-46-81
Новосибирск (383)227-86-73
Омск (3812)21-46-40
Орел (4862)44-53-42
Оренбург (3532)37-68-04
Пенза (8412)22-31-16
Казахстан (772)734-952-31

Пермь (342)205-81-47
Ростов-на-Дону (863)308-18-15
Рязань (4912)46-61-64
Самара (846)206-03-16
Санкт-Петербург (812)309-46-40
Саратов (845)249-38-78
Севастополь (8692)22-31-93
Симферополь (3652)67-13-56
Смоленск (4812)29-41-54
Сочи (862)225-72-31
Ставрополь (8652)20-65-13
Таджикистан (992)427-82-92-69

Сургут (3462)77-98-35
Тверь (4822)63-31-35
Томск (3822)98-41-53
Тула (4872)74-02-29
Тюмень (3452)66-21-18
Ульяновск (8422)24-23-59
Уфа (347)229-48-12
Хабаровск (4212)92-98-04
Челябинск (351)202-03-61
Череповец (8202)49-02-64
Ярославль (4852)69-52-93

**Pressione d'esercizio***Working Pressures**Betriebsdruck**Pression de service**Presión de Ejercicio**Pressão de Trabalho***0 bar****16 bar****Max pressione statica (no pulsazioni)***Maximum static pressure (no pulsations)**Maximaler statischer Betriebsdruck (ohne pulsations)**Pression statique maximale (sans pulsation)**Presión estática máxima (sin pulsaciones)**Pressão estática máxima (sem pulsações)***35 bar****Temperature***Temperatures**Temperatur**Températures**Temperaturas**Temperaturas***- 20 °C****+ 80 °C***Con O-ring in FKM**With FKM O-ring**Mit O-ring in FKM**Avec joints en FKM**Con junta tórica en FKM**Com O-ring em FKM***- 10 °C****+ 200 °C****Fluidi compatibili***Aria compressa**Fluids**Compressed air**Geeignete Medien**Druckluft**Fluides compatibles**Air comprimé**Fluidos compatibles**Aire comprimido**Fluidos compatíveis**Ar comprimido***Per altri fluidi, consultare l'ufficio tecnico Aignep.***For other fluids, consult the technical department Aignep.**Für andere Flüssigkeiten, kontaktieren Sie uns.**Pour d'autres fluides, veuillez nous consulter.**Para otros fluidos póngase en contacto con el departamento técnico Aignep.**Para outros fluidos consulte o departamento técnico da Aignep.***Portata****NI/min***Flow Rate**Durchflusswerte**Débit**Caudal de Flujo**Vazão*

DN	6 bar Δ 1	6 bar Δ 0.5	6 bar *
7.5	1750	1100	2400
7.8	1900	1300	2450

* Scarico libero - Exhaust Free - Kostenlose Auspuff - Échappement libre - Escape Libre - Descarga livre.

**Filettatura****IT***Gas cilindrica conforme ISO 228 Classe A.***Threads****GB***Parallel gas in conformity with ISO 228 Class A.***Gewindearten****DE***Zylindrisches Gewinde nach Norm ISO 228 Classe A.***Filetages****FR***Filetage cylindrique conforme: ISO 228 Classe A.***Roscas****ES***Gas cilindrica conforme ISO 228 Clase A.***Roscas****PT***Gas paralela conforme ISO 228 Classe A.*

161

PRESA MASCHIO

MALE SOCKET
 VERSCHLUSS-KUPPLUNG MIT AUSSENGEWINDE
 COUPLEUR MÂLE
 ENCHUFE MACHO
 SOQUETE COM ROSCA MACHO

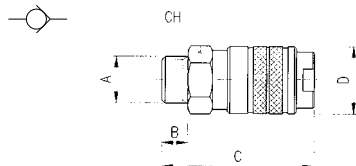

Code	A	B	C	D	CH	Pack.
00161 00 001	1/4	8	48	24	21	10
00161 00 002	3/8	9	49	24	21	10
00161 00 003	1/2	10	50	24	24	10

162

PRESA FEMMINA

FEMALE SOCKET
 VERSCHLUSS-KUPPLUNG MIT INNENGEWINDE
 COUPLEUR FEMELLE
 ENCHUFE HEMBRA
 SOQUETE COM ROSCA FÊMEA

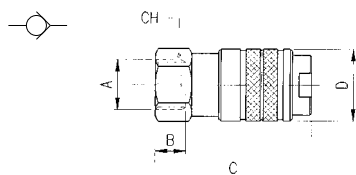

Code	A	B	C	D	CH	Pack.
00162 00 001	1/4	11	51	24	21	10
00162 00 002	3/8	11.5	51.5	24	21	10
00162 00 003	1/2	14	55	24	24	10

163

PRESA A CALZAMENTO CON MOLLA

COMPRESSION SOCKET WITH SPRING
 VERSCHLUSS-KUPPLUNG MIT KNICKSCHUTZFEDER
 COUPLEUR AVEC RESSORT DE PROTECTION
 ENCHUFE TUBO CON MUELLE
 SOQUETE COM CONEXÃO PUSH-ON COM MOLA

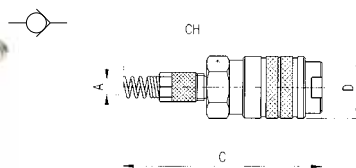

Code	A	C	D	CH	Pack.
00163 00 001	6/4	138	24	21	10
00163 00 002	8/6	143.5	24	21	10
00163 00 003	10/8	151	24	21	10
00163 00 007	12/10	161.5	24	21	10

Molla Acciaio Inox AISI 304 - EN 1.4301
 Stainless Steel Spring AISI 304 - EN 1.4301
 Edelstahlfeder AISI 304 - EN 1.4301
 Ressort Acier Inoxydable AISI 304 - EN 1.4301
 Muelle Acero Inoxidable AISI 304 - EN 1.4301
 Mola Aço Inoxidável AISI 304 - EN 1.4301

164

PRESA A CALZAMENTO

COMPRESSION SOCKET
 VERSCHLUSS-KUPPLUNG MIT ÜBERWURFVERSCHRAUBUNG
 COUPLEUR RACCORD À COIFFE
 ENCHUFE TUBO
 SOQUETE COM CONEXÃO PUSH-ON

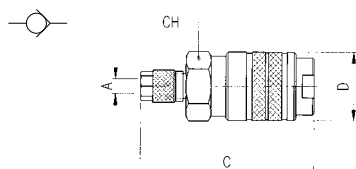

Code	A	C	D	CH	Pack.
00164 00 001	6/4	59	24	21	10
00164 00 002	8/6	59	24	21	10
00164 00 003	10/8	60	24	21	10
00164 00 007	12/10	62	24	21	10

165

PRESA CON PORTAGOMMA A RESCA

SOCKET WITH REST FOR RUBBER HOSE
 VERSCHLUSS-KUPPLUNG MIT SCHLAUCHTÜLLE
 COUPLEUR À DOUILLE ANNELÉE POUR TUBE
 ENCHUFE ESPIGA
 SOQUETE COM ESPIGÃO PARA MANGUEIRA DE BORRACHA

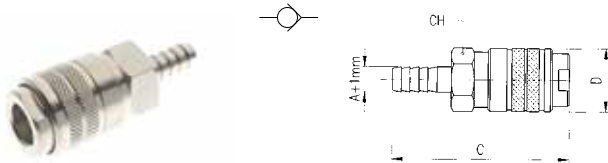

Code	A	C	D	CH	Pack.
00165 00 001	6	61	24	21	10
00165 00 002	8	61	24	21	10
00165 00 003	10	61	24	21	10
00165 00 004	12	61	24	21	10

166

PRESA CON PORTAGOMMA

SOCKET FOR RUBBER HOSE
 VERSCHLUSS-KUPPLUNG FÜR GUMMISCHLAUCH
 COUPLEUR À DOUILLE ANNELÉE POUR TUBE
 ENCHUFE CON PORTAGOMA
 SOQUETE COM ESPIGÃO PARA TUBO DE BORRACHA

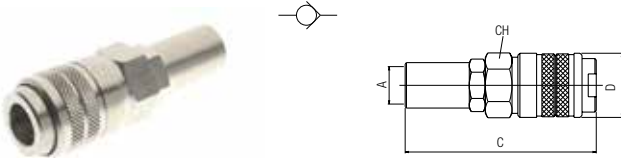

Code	A	C	D	CH	Pack.
00166 00 001	14/6	80	24	21	10
00166 00 002	17/8	84	24	21	10
00166 00 003	19/10	85	24	24	10

261

INNESTO MASCHIO

MALE PLUG
 STECKER MIT AUSSENGEWINDE
 EMBOUT MÂLE
 ADAPTADOR MACHO
 PLUG COM ROSCA MACHO

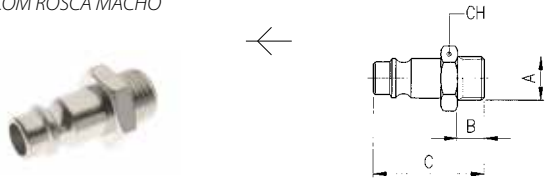

Code	A	B	C	CH	Pack.
00261 00 01 03 NB	1/4	8	33	17	10
00261 00 01 04 NB	3/8	9	34	19	10
00261 00 01 05 NB	1/2	10	35.5	24	10

261AC DN 7.8

INNESTO IN ACCIAIO MASCHIO

STEEL MALE PLUG
 STECKER MIT AUSSENGEWINDE AUS STAHL
 EMBOUT MÂLE EN ACIER
 ADAPTADOR EN ACERO MACHO
 PLUG EM AÇO COM ROSCA MACHO

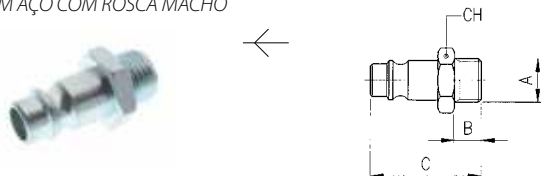

Code	A	B	C	CH	Pack.
261AC 00 51 03 ZI	1/4	8	33	17	10
261AC 00 51 04 ZI	3/8	9	34	19	10
261AC 00 51 05 ZI	1/2	10	35.5	24	10

Acciaio Indurito
 Hardened Steel
 Gehärtetem Stahl
 Acier Trempé
 Acero Curtido
 Aço Endurecido

262

INNESTO FEMMINA

FEMALE PLUG
 STECKER MIT INNENGEWINDE
 EMBOUT FEMELLE
 ADAPTADOR HEMBRA
 PLUG COM ROSCA FÊMEA

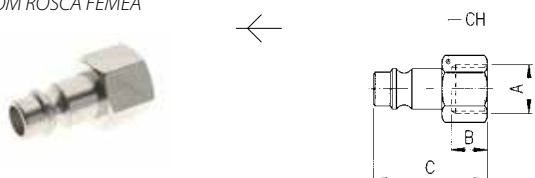

Code	A	B	C	CH	Pack.
00262 00 01 03 NB	1/4	11	33	17	10
00262 00 01 04 NB	3/8	11.5	33.5	19	10
00262 00 01 05 NB	1/2	14	36	24	10

262AC DN 7.8

INNESTO IN ACCIAIO FEMMINA

STEEL FEMALE PLUG

STECKER MIT INNENGEWINDE AUS STAHL

EMBOUT FEMELLE EN ACIER

ADAPTADOR EN ACERO HEMBRA

PLUG EM AÇO COM ROSCA FÊMEA

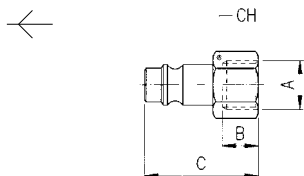

Code	A	B	C	CH	Pack.
262AC 00 51 03 ZI	1/4	11	33	17	10
262AC 00 51 04 ZI	3/8	11.5	33.5	19	10
262AC 00 51 05 ZI	1/2	14	36	24	10

Acciaio Indurito
 Hardened Steel
 Gehärtetem Stahl
 Acier Trempé
 Acero Curtido
 Aço Endurecido

263

INNESTO A CALZAMENTO CON MOLLA

COMPRESSION PLUG WITH SPRING

STECKER MIT KNICKSCHUTZFEDER

EMBOUT AVEC RESSORT DE PROTECTION

ADAPTADOR TUBO CON MUELLE

PLUG COM CONEXÃO PUSH-ON COM MOLLA

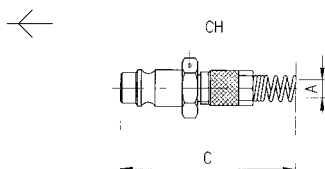

Code	A	C	CH	Pack.
00263 00 001	6/4	124.5	13	10
00263 00 002	8/6	130	13	10
00263 00 003	10/8	137.5	14	10
00263 00 004	12/10	143	16	10

Molla Acciaio Inox AISI 304 - EN 1.4301
 Stainless Steel Spring AISI 304 - EN 1.4301
 Edelstahlfeder AISI 304 - EN 1.4301
 Ressort Acier Inoxydable AISI 304 - EN 1.4301
 Muelle Acero Inoxidable AISI 304 - EN 1.4301
 Mola Aço Inoxidável AISI 304 - EN 1.4301

264

INNESTO A CALZAMENTO

COMPRESSION PLUG

STECKER MIT ÜBERWURFVERSCHRAUBUNG

EMBOUT À RACCORD À COIFFE

ADAPTADOR TUBO

PLUG COM CONEXÃO PUSH-ON

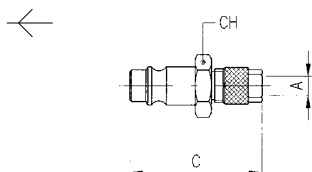

Code	A	C	CH	Pack.
00264 00 001	6/4	36	13	10
00264 00 002	8/6	36.5	13	10
00264 00 003	10/8	38.5	14	10
00264 00 004	12/10	47.5	16	10

265

INNESTO CON PORTAGOMMA A RESCA

PLUG WITH REST FOR RUBBER HOSE

STECKER MIT SCHLAUCHTÜLLE

EMBOUT À DOUILLE ANNELÉE POUR TUBE

ADAPTADOR ESPIGA

PLUG COM ESPIGÃO PARA TUBO DE BORRACHA

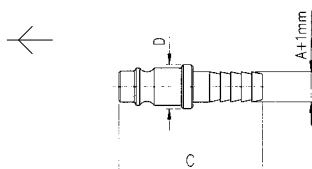

Code	A	C	D	Pack.
00265 00 01 X4 NB	6	39.5	12	10
00265 00 01 X7 NB	8	39.5	12	10
00265 00 01 X9 NB	10	42.5	14	10
00265 00 01 Y1 NB	12	42.5	16	10

265AC DN 7.8

INNESTO IN ACCIAIO CON PORTAGOMMA A RESCA

STEEL PLUG WITH REST FOR RUBBER HOSE

STECKER MIT SCHLAUCHTÜLLE AUS STAHL

EMBOUÏT À DOUILLE ANNELÉE POUR TUBE EN ACIER

ADAPTADOR EN ACERO ESPIGA

PLUG EM AÇO COM ESPIGÃO PARA TUBO DE BORRACHA

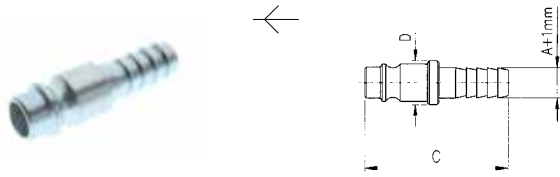

Code	A	C	D	Pack.
265AC 00 51 X4 ZI	6	39.5	12	10
265AC 00 51 X7 ZI	8	39.5	12	10
265AC 00 51 X9 ZI	10	42.5	14	10
265AC 00 51 Y1 ZI	12	42.5	16	10

Acciaio Indurito
Hardened Steel
Gehärtetem Stahl
Acier Trempé
Acero Curtido
Aço Endurecido

266

INNESTO CON PORTAGOMMA

PLUG FOR RUBBER HOSE

STECKER FÜR GUMMISCHLAUCH

EMBOUÏT POUR TUBE

ADAPTADOR CON PORTAGOMA

PLUG COM ESPIGÃO PARA TUBO DE BORRACHA

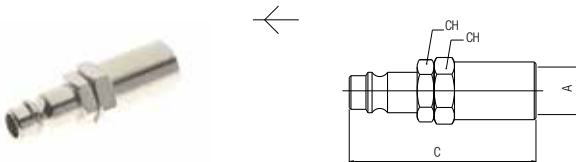

Code	A	C	CH1	CH2	Pack.
00266 00 001	14/6	55	15	17	10
00266 00 002	17/8	55	15	20	10
00266 00 003	19/10	55	15	22	10

267

INNESTO A BAIONETTA

BAYONET PLUG

STECKER MIT BAJONETT-VERSCHLUSS

EMBOUÏT À BAIONNETTE

ADAPTADOR BAYONETA

PLUG COM CONEXÃO TIPO BAIONETA

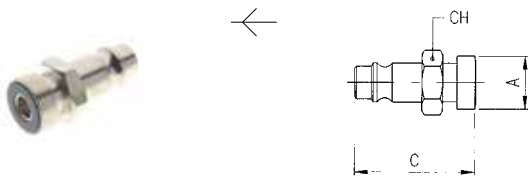

Code	A	C	CH	Pack.
00267 00 001	15	33.5	15	10

268

INNESTO A SCARICO PROGRESSIVO

PLUG WITH GRADUAL EXHAUST

STECKER MIT PROGRESSIVER ENTLASTUNG

EMBOUÏT À PASSAGE PROGRESSIF

ADAPTADOR DE DESCARGA PROGRESIVA

PLUG COM ESCAPE PROGRESSIVO

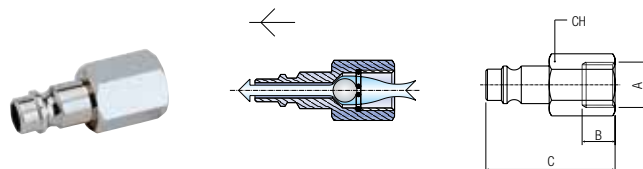

Code	A	B	C	CH	Pack.
00268 00 001	1/4	11	41.5	17	10

Архангельск (8182)63-90-72
Астана (7172)727-132
Астрахань (8512)99-46-04
Барнаул (3852)73-04-60
Белгород (4722)40-23-64
Брянск (4832)59-03-52
Владивосток (423)249-28-31
Волгоград (844)278-03-48
Волгодга (8172)26-41-59
Воронеж (473)204-51-73
Екатеринбург (343)384-55-89
Иваново (4932)77-34-06

Ижевск (3412)26-03-58
Иркутск (395)279-98-46
Казань (843)206-01-48
Калининград (4012)72-03-81
Калуга (4842)92-23-67
Кемерово (3842)65-04-62
Киров (8332)68-02-04
Краснодар (861)203-40-90
Красноярск (391)204-63-61
Курск (4712)77-13-04
Липецк (4742)52-20-81
Киргизия (996)312-96-26-47

Магнитогорск (3519)55-03-13
Москва (495)268-04-70
Мурманск (8152)59-64-93
Набережные Челны (8552)20-53-41
Нижний Новгород (831)429-08-12
Новокузнецк (3843)20-46-81
Новосибирск (383)227-86-73
Омск (3812)21-46-40
Орел (4862)44-53-42
Оренбург (3532)37-68-04
Пенза (8412)22-31-16
Казахстан (772)734-952-31

Пермь (342)205-81-47
Ростов-на-Дону (863)308-18-15
Рязань (4912)46-61-64
Самара (846)206-03-16
Санкт-Петербург (812)309-46-40
Саратов (845)249-38-78
Севастополь (8692)22-31-93
Симферополь (3652)67-13-56
Смоленск (4812)29-41-54
Сочи (862)225-72-31
Ставрополь (8652)20-65-13
Таджикистан (992)427-82-92-69

Сургут (3462)77-98-35
Тверь (4822)63-31-35
Томск (3822)98-41-53
Тула (4872)74-02-29
Тюмень (3452)66-21-18
Ульяновск (8422)24-23-59
Уфа (347)229-48-12
Хабаровск (4212)92-98-04
Челябинск (351)202-03-61
Череповец (8202)49-02-64
Ярославль (4852)69-52-93