

Serie Tubes

Tubi e Spirali in Poliamide

Polyamide Tubes and Spirals
Rohre und Spiralrohre aus Polyamid
Tubes et Tubes Spirales en Polyamide
Tubo y Espirales en Poliamida
Tubos e Espirais de Poliamida

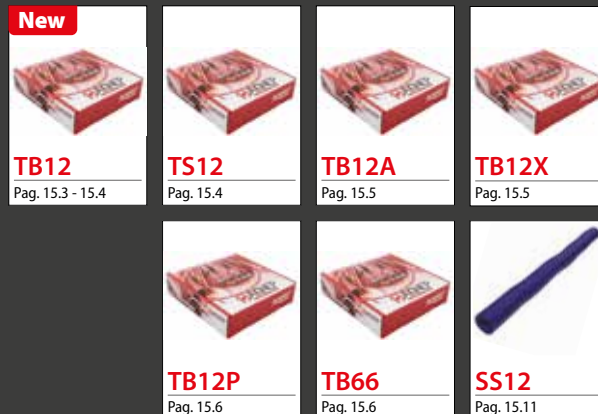

Tubi e Spirali in Poliuretano Poliestere 98 Shore A

Polyurethane Polyester 98 Shore A Tubes and Spirals
Rohre und Spiralrohre aus Polyurethan-Polyether 98 Shore A
Tubes et Tubes Spirales en Polyuréthane Polyéther 98 Shore A
Tubo y Espirales en Poliuretano Poliéster 98 Shore A
Tubos e Espirais de Poliuretano Poliéster 98 Shore A



Tubi in Poliuretano Polietere 90 Shore A

Polyether Polyurethane 90 Shore A Tubes
Rohre aus Polyurethan-Polyether 90 Shore A
Tubes en Polyuréthane Polyéther 90 Shore A
Tubo y Espirales en Poliuretano Poliéter 90 Shore A
Tubos e Espirais de Poliuretano Poliéster 90 Shore A



Tubi in FEP - PTFE

FEP - PTFE Tubes
Rohre aus FEP - PTFE
Tubes en FEP - PTFE
Tubo en FEP - PTFE
Tubos de FEP - PTFE



Tubo PVC

PVC Tube
PVC Rohr
Tuyau PVC
Tubo PVC
Tubo de PVC

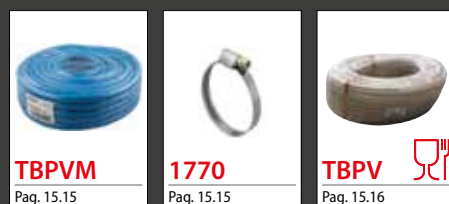

Tubi Autobloccanti

Push-Lock Tubes
Schnellsteckschläuche
Tuyaux Auto-Serrants
Tubería Autoblocante
Tubo Push-Lock



Accessori

Accessories
Zubehör
Accessoires
Accesorios
Acessórios



Kit soffiaggio

Blower Kit
Gebläse-Kit
Kit soufflette
Kit de ventilador
Kit ventilador

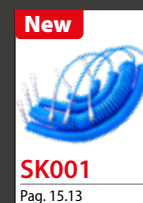

Архангельск (8182)63-90-72
Астана (7172)727-132
Астрахань (8512)99-46-04
Барнаул (3852)73-04-60
Белгород (4722)40-23-64
Брянск (4832)59-03-52
Владивосток (423)249-28-31
Волгоград (844)278-03-48
Вологда (8172)26-41-59
Воронеж (473)204-51-73
Екатеринбург (343)384-55-89
Иваново (4932)77-34-06

Ижевск (3412)26-03-58
Иркутск (395)279-98-46
Казань (843)206-01-48
Калининград (4012)72-03-81
Калуга (4842)92-23-67
Кемерово (3842)65-04-62
Киров (8332)68-02-04
Краснодар (861)203-40-90
Красноярск (391)204-63-61
Курск (4712)77-13-04
Липецк (4742)52-20-81
Киргизия (996)312-96-26-47

Магнитогорск (3519)55-03-13
Москва (495)268-04-70
Мурманск (8152)59-64-93
Набережные Челны (8552)20-53-41
Нижний Новгород (831)429-08-12
Новокузнецк (3843)20-46-81
Новосибирск (383)227-86-73
Омск (3812)21-46-40
Орел (4862)44-53-42
Оренбург (3532)37-68-04
Пенза (8412)22-31-16
Казахстан (772)734-952-31

Пермь (342)205-81-47
Ростов-на-Дону (863)308-18-15
Рязань (4912)46-61-64
Самара (846)206-03-16
Санкт-Петербург (812)309-46-40
Саратов (845)249-38-78
Севастополь (8692)22-31-93
Симферополь (3652)67-13-56
Смоленск (4812)29-41-54
Сочи (862)225-72-31
Ставрополь (8652)20-65-13
Таджикистан (992)427-82-92-69

Сургут (3462)77-98-35
Тверь (4822)63-31-35
Томск (3822)98-41-53
Тула (4872)74-02-29
Тюмень (3452)66-21-18
Ульяновск (8422)24-23-59
Уфа (347)229-48-12
Хабаровск (4212)92-98-04
Челябинск (351)202-03-61
Череповец (8202)49-02-64
Ярославль (4852)69-52-93

TUBI IN MATERIALE PLASTICO

PLASTIC TUBES

PLASTIK ROHRE

TUBES ET TUYAUX TECHNIQUES

TUBOS EN MATERIAL PLÁSTICO

TUBOS EM MATERIAL PLÁSTICO



Serie Tubes

TUBES



CARATTERISTICHE TECNICHE

TECHNICAL CHARACTERISTICS
TECHNISCHE ANGABEN
CARACTÉRISTIQUES TECHNIQUES
CARACTERÍSTICAS TÉCNICAS
CARACTERÍSTICAS TÉCNICAS



Norma di Riferimento

Reference standard
Entspricht der Norm
Norme de référence
Normativa de referencia
Norma de referência

1907/2006
REACH ✓

2011/65/CE
RoHS ✓

PEP
2014/68/UE

SILICON
FREE

MATERIALI
MATERIALS
MATERIALIEN
MATERIAUX
MATERIALES
MATERIAIS

POLIAMIDE
POLYAMIDE
POLYAMID
POLYAMIDE
POLIAMIDA
POLIAMIDA

POLIURETANO 98 SHORE A
POLYURETHANE 98 SHORE A
POLYURETHAN 98 SHORE A
POLYURÉTHANE 98 SHORE A
POLIURETANO 98 SHORE A
POLIURETANO 98 SHORE A

PTFE

FEP

PVC

NBR/PVC

COLORI STANDARD
STANDARD COLORS
STANDARD FARBEN
COULEURS STANDARDS
COLORES STANDARD
CORES PADRÃO

	NT	NEUTRO NEUTRAL NEUTRAL NEUTRE NEUTRAL NEUTRO
	AZ	AZZURRO LIGHT BLUE HELLBLAU BLEU CLAIR AZUL AZUL CLARO
	BL	BLU BLUE BLAU BLEU AZUL OSCURO AZUL
	NE	NERO BLACK SCHWARZ NOIR NEGRO PRETO

	GI	GIALLO YELLOW GELB JAUNE AMARILLO AMARELO
	GR	GRIGIO GREY GRAU GRIS GRIS CINZA
	RO	ROSSO RED ROT ROUGE ROJO VERMELHO
	VE	VERDE GREEN GRÜN VERT VERDE VERDE

TUBO IN POLIAMIDE

POLYAMIDE TUBE
ROHRE AUS POLYAMID
TUBE POLYAMIDE
TUBO EN POLIAMIDA
TUBO DE POLIAMIDA

TB12

TUBO IN POLIAMIDE
POLYAMIDE TUBE
ROHRE AUS POLYAMID IN SCHACHTELN
TUBE POLYAMIDE
TUBO EN POLIAMIDA
TUBO DE POLIAMIDA

New



= Anti UV

Code	Colore Color Farbe Couleur Color Cor							Est.	Int.	Raggio di curvatura Bending radius Biegeradius Rayon de courbure Radio curvatura Raio de curvatura	Pressione d'esercizio Working pressure Betriebsdruck Pression de travail Presión de ejercicio Pressão de trabalho	Pressione di scoppio Burst pressure Berstdruck Pression d'éclatement Presión de rotura Pressão de ruptura	Tolleranza Tolerance Toleranz Tolérance Tolerancia Tolerância	Pack.
TB12 00 210	-	-	NE	-	-	-	-	2	1	10	44	133	± 0.07	100
TB12 00 315	NT	-	NE	-	-	-	-	3	1.5	10	44	133	± 0.07	100
TB12 00 427	NT	AZ	NE	GI	GR	RO	VE	4	2.7	25	26	78	± 0.07	100
TB12 00 530	NT	AZ	NE	-	-	-	-	5	3	30	33	100	± 0.07	100
TB12 00 640	NT	AZ	NE	GI	GR	RO	VE	6	4	30	27	80	± 0.07	100
TB12 00 860	NT	AZ	NE	GI	GR	RO	VE	8	6	40	19	57	± 0.07	100
TB12 01 075	NT	-	NE	-	-	-	-	10	7.5	60	19	57	± 0.07	100
TB12 01 080	NT	AZ	NE	GI	GR	RO	VE	10	8	60	15	44	± 0.07	100
TB12 12 100	NT	AZ	NE	-	-	-	-	12	10	85	12	36	± 0.10	100
TB12 14 120	NT	AZ	NE	-	-	-	-	14	12	100	10	30	± 0.10	50
TB12 15 125	NT	AZ	NE	-	-	-	-	15	12.5	100	12	36	± 0.10	50
TB12 16 120	NT	-	NE	-	-	-	-	16	12	95	19	57	± 0.10	50

TUBO IN POLIAMIDE DIMENSIONI IN POLLICI

POLYAMIDE TUBE INCHES DIMENSIONS

ROHRE AUS POLYAMID (ZOLLMASS)

TUBE POLYAMIDE (DIMENSIONS EN POUCE)

TUBO EN POLIAMIDA DIMENSIONES EN PULGADA

TUBO DE POLIAMIDA DIMENSÕES EM POLEGADAS

Code	Colore Color Farbe Couleur Color Cor	Est. mm	Int. mm	Raggio di curvatura Bending radius Biegeradius Rayon de courbure Radio curvatura Raio de curvatura	Pressione d'esercizio Working pressure Betriebsdruck Pression de travail Presión de ejercicio Pressão de trabalho	Pressione di scoppio Burst pressure Berstdruck Pression d'éclatement Presión de rotura Pressão de ruptura	Tolleranza Tolerance Toleranz Tolérance Tolerancia Tolerância	Pack. Mt
TB12 31 721	NE	1/8 (3.17)	2.18	25	24	74	± 0.07	100
TB12 63 543	NE	1/4 (6.35)	4.35	40	24	74	± 0.07	100
TB12 95 271	NE	3/8 (9.52)	7.14	55	19	57	± 0.07	100
TB12 12 795	NE	1/2 (12.7)	9.52	65	19	57	± 0.10	100

TS12

TUBO IN POLIAMIDE - LUNGHEZZA 25 Mt

POLYAMIDE TUBE - LENGHT 25 Mt

ROHRE AUS POLYAMID - LÄNGE 25 Mt

TUBE POLYAMIDE - ROULEAU DE 25 Mt

TUBO EN POLIAMIDA - LONGITUD 25 Mt

TUBO DE POLIAMIDA - LUNGHEZZA 25 Mt



= Anti UV

Code	Colore Color Farbe Couleur Color Cor	Est. mm	Int. mm	Raggio di curvatura Bending radius Biegeradius Rayon de courbure Radio curvatura Raio de curvatura	Pressione d'esercizio Working pressure Betriebsdruck Pression de travail Presión de ejercicio Pressão de trabalho	Pressione di scoppio Burst pressure Berstdruck Pression d'éclatement Presión de rotura Pressão de ruptura	Tolleranza Tolerance Toleranz Tolérance Tolerancia Tolerância	Pack.
TS12 00 427	NT AZ NE GI GR RO VE	4	2.7	25	26	78	± 0.07	1
TS12 00 530	NT AZ NE - - - -	5	3	30	33	100	± 0.07	1
TS12 00 640	NT AZ NE GI GR RO VE	6	4	30	27	80	± 0.07	1
TS12 00 860	NT AZ NE GI GR RO VE	8	6	40	19	57	± 0.07	1
TS12 01 080	NT AZ NE - - - -	10	8	60	15	44	± 0.07	1
TS12 12 100	NT AZ NE - - - -	12	10	85	12	36	± 0.10	1
TS12 14 120	NT AZ NE - - - -	14	12	100	10	30	± 0.10	1

TUBO IN POLIAMIDE DIMENSIONI IN POLLICI - LUNGHEZZA 25 Mt

POLYAMIDE TUBE INCHES DIMENSIONS - LENGHT 25 Mt

ROHRE AUS POLYAMID (ZOLLMASS) - LÄNGE 25 Mt

TUBE POLYAMIDE (DIMENSIONS EN POUCE) - ROULEAU DE 25 Mt

TUBO EN POLIAMIDA DIMENSIONES EN PULGADA - LONGITUD 25 Mt

TUBO DE POLIAMIDA DIMENSÕES EM POLEGADAS - LONGITUDE 25 Mt

Code	Colore Color Farbe Couleur Color Cor	Est. Inch	Int. Inch	Raggio di curvatura Bending radius Biegeradius Rayon de courbure Radio curvatura Raio de curvatura	Pressione d'esercizio Working pressure Betriebsdruck Pression de travail Presión de ejercicio Pressão de trabalho	Pressione di scoppio Burst pressure Berstdruck Pression d'éclatement Presión de rotura Pressão de ruptura	Tolleranza Tolerance Toleranz Tolérance Tolerancia Tolerância	Pack.
TS12 31 721	NE	1/8 (3.17)	2.18	25	24	74	± 0.07	1
TS12 63 543	NE	1/4 (6.35)	4.35	40	24	74	± 0.07	1
TS12 95 271	NE	3/8 (9.52)	7.14	55	19	57	± 0.07	1
TS12 12 795	NE	1/2 (12.7)	9.52	65	19	57	± 0.10	1



Temperatura d'uso

Temperature Range

Temperaturbereich

Température d'utilisation

Temperatura de Ejercicio

Temperatura de Trabalho

- 40 °C
+ 100 °C



Tabella delle pressioni espresse in % in funzione della temperatura
Table of pressure values expressed in% as a function of temperature
Tabelle In Abhängigkeit Der Temperaturen Die Druckwerte In % Angegeben
Valeurs de pression (en %) en fonction de la température
Tabla de las presiones expresadas en % en función de la temperatura
Tabela das pressões expressas em % em função da temperatura

20°	40°	60°	80°	100°
100%	85%	60%	40%	20%

TB12A

TUBO IN POLIAMIDE AUTOESTINGUENTE

PA SELF-EXTINGUISHING TUBE
 POLYAMID-ROHR FEUERRESISTENT
 TUBE POLYAMIDE AUTO EXTINGUIBLE
 TUBO EN POLIAMIDA AUTOEXTINGUENTE
 TUBO EM POLIURETANO ANTI-PROPAGAÇÃO DE CHAMAS



UL 94 V2

Code	Colore Color Farbe Couleur Color Cor	Est.	Int.	Raggio di curvatura Bending radius Biegeradius Rayon de courbure Radio curvatura Raio de curvatura	Pressione d'esercizio Working pressure Betriebsdruck Pression de travail Presión de ejercicio Pressão de trabalho		Pressione di scoppio Burst pressure Berstdruck Pression d'éclatement Presión de rotura Pressão de ruptura		Pack.
					a/at 20°C	a/at 20°C	a/at 20°C	a/at 20°C	
		mm	mm	mm	bar	bar	bar	Mt	
TB12A 00 427	AZ	4	2.7	25	28	85	100		
TB12A 00 640	AZ	6	4	35	29	88	100		
TB12A 00 860	AZ	8	6	40	21	63	100		
TB12A 01 080	AZ	10	8	60	16	49	100		
TB12A 12 100	AZ	12	10	85	13	40	100		
TB12A 15 125	AZ	15	12.5	100	13	40	50		



Temperatura d'uso

Temperature Range

Temperaturbereich



Température d'utilisation

Temperatura de Ejercicio

Temperatura de Trabalho

- 30 °C

+ 70 °C

Tabella delle pressioni espresse in % in funzione della temperatura
 Table of pressure values expressed in% as a function of temperature
 Tabelle In Abhängigkeit Der Temperaturen Die Druckwerte In % Angegeben
 Valeurs de pression (en %) en fonction de la température
 Tabla de las presiones expresadas en % en función de la temperatura
 Tabela das pressões expressas em % em função da temperatura

20°	30°	40°	50°	60°
100%	72%	64%	52%	47%

TB12X

TUBO IN POLIAMIDE MULTISTRATO ANTISTATICO

PA MULTILAYER ANTISTATIC TUBE
 POLYAMID-ROHR ANTISTATISCH
 TUBE POLYAMIDE ANTISTATIQUE
 TUBO EN POLIAMIDA MULTICAPA ANTIESTÁTICO
 TUBO EM POLIAMIDA MULTI-CAMADAS ANTI-ESTÁTICO



Ex ATEX II 2 G/D

Code	Colore Color Farbe Couleur Color Cor	Est.	Int.	Raggio di curvatura Bending radius Biegeradius Rayon de courbure Radio curvatura Raio de curvatura	Pressione d'esercizio Working pressure Betriebsdruck Pression de travail Presión de ejercicio Pressão de trabalho		Pressione di scoppio Burst pressure Berstdruck Pression d'éclatement Presión de rotura Pressão de ruptura		Tolleranza Tolerance Toleranz Tolerancia Tolerância	Pack.
					a/at 20°C	a/at 20°C	a/at 20°C	a/at 20°C		
		mm	mm	mm	bar	bar	mm	Mt		
TB12X 00 425	NE	4	2.5	30	25	74	± 0.10	100		
TB12X 00 640	NE	6	4	45	15	45	± 0.10	100		
TB12X 00 860	NE	8	6	55	10	29	± 0.10	100		
TB12X 01 080	NE	10	8	70	7	21	± 0.10	100		
TB12X 12 100	NE	12	10	100	5	16	± 0.10	100		



Temperatura d'uso

Temperature Range

Temperaturbereich



Température d'utilisation

Temperatura de Ejercicio

Temperatura de Trabalho

- 30 °C

+ 80 °C

Tabella delle pressioni espresse in % in funzione della temperatura
 Table of pressure values expressed in% as a function of temperature
 Tabelle In Abhängigkeit Der Temperaturen Die Druckwerte In % Angegeben
 Valeurs de pression (en %) en fonction de la température
 Tabla de las presiones expresadas en % en función de la temperatura
 Tabela das pressões expressas em % em função da temperatura

20°	40°	60°	80°
100%	85%	60%	40%

TB12P

TUBO IN POLIAMIDE RIVESTITO IN PU ANTISCINTILLA IGNIFUGO

PA TUBE WITH PU LAYER – FIREPROOF ANTI-SPARK

POLYAMID-ROHR SCHWEISSSPRITZABWEISEND

TUBE POLYAMIDE AVEC GAINÉ EN PU IGNIFUGE ANTI ETINCELLE

TUBO EN POLIAMIDA REVESTIDO EN PU ANTICHISPA IGNIFUGO

TUBO EM POLIAMIDA REVESTIDO EM PU ANTI-CHAMA



UL 94 V0

Code	Colore Color Farbe Couleur Color Cor	Est.	Int.	Est. Cover	Raggio di curvatura Bending radius Biegeradius Rayon de courbure Radio curvatura Raio de curvatura	Pressione d'esercizio Working pressure Betriebsdruck Pression de travail Presión de ejercicio Pressão de trabalho	Pressione di scoppio Burst pressure Berstdruck Pression d'éclatement Presión de rotura Pressão de ruptura	Pack.
		mm	mm	mm	mm	bar	bar	
TB12P 00 420	NE	4	2	6	10	56	167	100
TB12P 00 640	NE	6	4	8	20	33	100	100
TB12P 00 860	NE	8	6	10	30	24	71	100
TB12P 01 075	NE	10	7.5	12	40	24	71	100
TB12P 01 290	NE	12	9	14	70	24	71	100



Temperatura d'uso

Temperature Range

Temperaturbereich



Température d'utilisation

Temperatura de Ejercicio

Temperatura de Trabalho

- 40 °C

+ 80 °C

Tabella delle pressioni espresse in % in funzione della temperatura

Table of pressure values expressed in% as a function of temperature

Tabelle In Abhängigkeit Der Temperaturen Die Druckwerte In % Angegeben

Valeurs de pression (en %) en fonction de la température

Tabla de las presiones expresadas en % en función de la temperatura

Tabela das pressões expressas em % em função da temperatura

20°	40°	60°	80°
100%	85%	60%	40%

TB66

TUBO IN POLIAMIDE RIGIDO

POLYAMIDE SEMIRIGID TUBE

ROHRE AUS POLYAMID, HALBSTARR

TUBE POLYAMIDE RIGIDE

TUBO EN POLIAMIDA RÍGIDO

TUBO RÍGIDO EM POLIAMIDA



serie 58000

Code	Colore Color Farbe Couleur Color Cor	Est.	Int.	Raggio di curvatura Bending radius Biegeradius Rayon de courbure Radio curvatura Raio de curvatura	Pressione d'esercizio Working pressure Betriebsdruck Pression de travail Presión de ejercicio Pressão de trabalho	Pressione di scoppio Burst pressure Berstdruck Pression d'éclatement Presión de rotura Pressão de ruptura	Pack.
		mm	mm	mm	bar	bar	
TB66 00 420	NT	4	2	25	100	300	100
TB66 00 630	NT	6	3	45	100	300	100



Temperatura d'uso

Temperature Range

Temperaturbereich



Température d'utilisation

Temperatura de Ejercicio

Temperatura de Trabalho

0 °C

+ 100 °C

Tabella delle pressioni espresse in % in funzione della temperatura

Table of pressure values expressed in% as a function of temperature

Tabelle In Abhängigkeit Der Temperaturen Die Druckwerte In % Angegeben

Valeurs de pression (en %) en fonction de la température

Tabla de las presiones expresadas en % en función de la temperatura

Tabela das pressões expressas em % em função da temperatura

20°	30°	40°	50°	60°	70°	80°
100%	83%	72%	64%	58%	52%	47%

TUBO IN POLIURETANO POLIESTERE 98 SHORE A

98 SHORE A POLYURETHANE POLYESTER TUBE
 ROHRE AUS POLYURETHAN-POLYESTER 98 SHORE A
 TUBE EN POLYURÉTHANE POLYESTER 98 SHORE A
 TUBO EN POLIURETANO POLIÉSTER 98 SHORE A
 TUBO DE POLIURETANO POLIÉSTER 98 SHORE A

TBPU

TUBO IN POLIURETANO POLIESTERE 98 SHORE A

98 SHORE A POLYURETHANE POLYESTER TUBE
 ROHRE AUS POLYURETHAN-POLYESTER 98 SHORE A
 TUBE EN POLYURÉTHANE POLYESTER 98 SHORE A
 TUBO EN POLIURETANO POLIÉSTER 98 SHORE A
 TUBO DE POLIURETANO POLIÉSTER 98 SHORE A



New

Code	Colore Color Farbe Couleur Color Cor					Est. mm	Int. mm	Raggio di curvatura Bending radius Biegeradius Rayon de courbure Radio curvatura Raio de curvatura	Pressione d'esercizio Working pressure Betriebsdruck Pression de travail Presión de ejercicio Pressão de trabalho	Pressione di scoppio Burst pressure Berstdruck Pression d'éclatement Presión de rotura Pressão de ruptura	Tolleranza Tolerance Toleranz Tolérance Tolerancia Tolerância	Pack. Mt
	White	Blue	Black	Yellow	Red							
TBPU 00 425	NT	AZ	NE	-	RO	4	2.5	15	10	40	± 0.10	100
TBPU 00 530	NT	AZ	NE	-	-	5	3	16	12	50	± 0.10	100
TBPU 00 640	NT	AZ	NE	GI	RO	6	4	18	10	40	± 0.10	100
TBPU 00 855	NT	AZ	NE	-	RO	8	5.5	30	10	40	± 0.10	100
TBPU 00 860	NT	AZ	NE	-	RO	8	6	35	7	28	± 0.10	100
TBPU 01 080	NT	AZ	NE	-	RO	10	8	45	5.5	22	± 0.15	100
TBPU 01 290	NT	AZ	NE	-	RO	12	9	50	6	25	± 0.15	100
TBPU 16 110	NT	AZ	NE	-	-	16	11	75	12	36	± 0.10	50

TSPU

TUBO IN POLIURETANO POLIESTERE 98 SHORE - LUNGHEZZA 25 Mt

98 SHORE A POLYURETHANE POLYESTER TUBE - LENGHT 25 Mt
 ROHRE AUS POLYURETHAN-POLYESTER 98 SHORE A - LÄNGE 25 Mt
 TUBE EN POLYURÉTHANE POLYESTER 98 SHORE A - ROULEAU DE 25 Mt
 TUBO EN POLIURETANO POLIÉSTER 98 SHORE A - LONGITUD 25 Mt
 TUBO DE POLIURETANO POLIÉSTER 98 SHORE A - COMPRIMENTO DE 25 Mt



Code	Colore Color Farbe Couleur Color Cor			Est. mm	Int. mm	Raggio di curvatura Bending radius Biegeradius Rayon de courbure Radio curvatura Raio de curvatura	Pressione d'esercizio Working pressure Betriebsdruck Pression de travail Presión de ejercicio Pressão de trabalho	Pressione di scoppio Burst pressure Berstdruck Pression d'éclatement Presión de rotura Pressão de ruptura	Tolleranza Tolerance Toleranz Tolérance Tolerancia Tolerância	Pack. Mt
	White	Blue	Black							
TSPU 00 425	NT	AZ	NE	4	2.5	15	10	40	± 0.10	1
TSPU 00 640	NT	AZ	NE	6	4	18	10	40	± 0.10	1
TSPU 00 855	NT	AZ	NE	8	5.5	30	10	40	± 0.10	1
TSPU 00 860	NT	AZ	NE	8	6	35	7	28	± 0.10	1
TSPU 01 080	NT	AZ	NE	10	8	45	5.5	22	± 0.15	1
TSPU 01 290	NT	AZ	NE	12	9	50	6	25	± 0.15	1



Temperatura d'uso

Temperature Range

Temperaturbereich

Température d'utilisation

Temperatura de Ejercicio

Temperatura de Trabalho

- 40 °C

+ 60 °C



Tabella delle pressioni espresse in % in funzione della temperatura
 Table of pressure values expressed in% as a function of temperature
 Tabelle In Abhängigkeit Der Temperaturen Die Druckwerte In % Angegeben.
 Valeurs de pression (en %) en fonction de la température
 Tabla de las presiones expresadas en % en función de la temperatura
 Tabela das pressões expressas em % em função da temperatura

-20°	0°	20°	30°	40°	50°	60°
185%	140%	100%	85%	70%	60%	50%

TUBO IN POLIURETANO POLIETERE 90 SHORE A

90 SHORE A POLYURETHANE POLYETHER TUBE
 ROHRE AUS POLYURETHAN-POLYETHER 90 SHORE A
 TUBE EN POLYURÉTHANE POLYÉTHÉR 90 SHORE A
 TUBO EN POLIURETANO POLIÉTER 90 SHORE A
 TUBO DE POLIURETANO POLIÉTER 90 SHORE A

TBPO

TUBO IN POLIURETANO POLIETERE 90 SHORE A

90 SHORE A POLYURETHANE POLYETHER TUBE
 ROHRE AUS POLYURETHAN-POLYETHER 90 SHORE A
 TUBE EN POLYURÉTHANE POLYÉTHÉR 90 SHORE A
 TUBO EN POLIURETANO POLIÉTER 90 SHORE A
 TUBO DE POLIURETANO POLIÉTER 90 SHORE A



Code	Colore Color Farbe Couleur Color Cor							Est. mm	Int. mm	Raggio di curvatura Bending radius Biegeradius Rayon de courbure Radio curvatura Raio de curvatura mm	Pressione d'esercizio Working pressure Betriebsdruck Pression de travail Presión de ejercicio Pressão de trabalho a/at 20°C bar	Pressione di scoppio Burst pressure Berstdruck Pression d'éclatement Presión de rotura Pressão de ruptura a/at 20°C bar	Tolleranza Tolerance Toleranz Tolérance Tolerancia mm	Pack. Mt
	White	Blue	Black	Yellow	Grey	Red	Green							
TBPO 00 425	NT	AZ	NE	GI	GR	RO	VE	4	2.5	20	12	37	± 0.07	100
TBPO 00 640	NT	AZ	NE	GI	GR	RO	VE	6	4	30	11	32	± 0.07	100
TBPO 00 855	NT	AZ	NE	GI	GR	RO	VE	8	5.5	45	10	30	± 0.07	100
TBPO 01 070	NT	AZ	NE	-	GR	RO	-	10	7	35	9	28	± 0.07	100
TBPO 01 280	NT	AZ	NE	-	GR	RO	-	12	8	30	11	32	± 0.07	100
TBPO 14 100	NT	AZ	NE	GI	-	RO	-	14	10	120	9	27	± 0.10	100

TSPO

TUBO IN POLIURETANO POLIETERE 90 SHORE A - LUNGHEZZA 25 Mt

90 SHORE A POLYURETHANE POLYETHER TUBE - LENGHT 25 Mt
 ROHRE AUS POLYURETHAN-POLYETHER 90 SHORE A - LÄNGE 25 Mt
 TUBE EN POLYURÉTHANE POLYÉTHÉR 90 SHORE A - ROULEAU DE 25 Mt
 TUBO EN POLIURETANO POLIÉTER 90 SHORE A - LONGITUD 25 Mt
 TUBO DE POLIURETANO POLIÉTER 90 SHORE A - COMPRIMENTO DE 25 Mt



Code	Colore Color Farbe Couleur Color Cor							Est. mm	Int. mm	Raggio di curvatura Bending radius Biegeradius Rayon de courbure Radio curvatura Raio de curvatura mm	Pressione d'esercizio Working pressure Betriebsdruck Pression de travail Presión de ejercicio Pressão de trabalho a/at 20°C bar	Pressione di scoppio Burst pressure Berstdruck Pression d'éclatement Presión de rotura Pressão de ruptura a/at 20°C bar	Tolleranza Tolerance Toleranz Tolérance Tolerancia mm	Pack.
	White	Blue	Black	Yellow	Grey	Red	Green							
TSPO 00 425	NT	AZ	NE	GI	GR	RO	VE	4	2.5	20	12	37	± 0.07	1
TSPO 00 640	NT	AZ	NE	GI	GR	RO	VE	6	4	30	11	32	± 0.07	1
TSPO 00 855	NT	AZ	NE	GI	GR	RO	VE	8	5.5	45	10	30	± 0.07	1
TSPO 01 070	NT	AZ	NE	-	GR	RO	-	10	7	35	9	28	± 0.07	1
TSPO 01 280	NT	AZ	NE	-	GR	RO	-	12	8	30	11	32	± 0.07	1
TSPO 14 100	NT	AZ	NE	GI	-	RO	-	14	10	120	9	27	± 0.07	1



Temperatura d'uso

Temperature Range

Temperaturbereich

Température d'utilisation

Temperatura de Ejercicio

Temperatura de Trabalho

- 40 °C

+ 60 °C



Tabella delle pressioni espresse in % in funzione della temperatura
 Table of pressure values expressed in % as a function of temperature
 Tabelle in Abhängigkeit Der Temperaturen Die Druckwerte In % Angegeben
 Valeurs de pression (en %) en fonction de la température
 Tabla de las presiones expresadas en % en función de la temperatura
 Tabela das pressões expressas em % em função da temperatura

20°	30°	40°
100%	60%	40%

TUBO IN FEP - PTFE

FEP - PTFE TUBE
 ROHRE AUS FEP - PTFE
 TUBE EN FEP - PTFE
 TUBO EN FEP - PTFE
 TUBO DE FEP - PTFE

TBFE

TUBO FEP
 FEP TUBE
 ROHRE AUS FEP
 TUBE EN FEP
 TUBO EN FEP
 TUBO DE FEP



Anti UV

Code	Colore Color Farbe Couleur Color Cor	Est. mm	Int. mm	Raggio di curvatura Bending radius Biegeradius Rayon de courbure Radio curvatura Raio de curvatura	Pressione d'esercizio	Pressione di scoppio	Tolleranza Tolerance Toleranz Tolérance Tolerancia Tolerância	Pack. Mt
					a/at 20°C bar	a/at 20°C bar		
TBFE 00 425	NT	4	2.5	21	22	110	± 0.07	50
TBFE 00 640	NT	6	4	36	19	96	± 0.07	50
TBFE 00 860	NT	8	6	64	14	70	± 0.07	50
TBFE 01 080	NT	10	8	100	11	55	± 0.07	50
TBFE 12 100	NT	12	10	144	9	45	± 0.07	50

TSFE

TUBO FEP - LUNGHEZZA 25 Mt
 FEP TUBE - LENGHT 25 Mt
 ROHRE AUS FEP - LÄNGE 25 Mt
 TUBE EN FEP - ROULEAU DE 25 Mt
 TUBO FEP - LONGITUD 25 Mt
 TUBO FEP - COMPRIMENTO DE 25 Mt



Anti UV

Code	Colore Color Farbe Couleur Color Cor	Est. mm	Int. mm	Raggio di curvatura Bending radius Biegeradius Rayon de courbure Radio curvatura Raio de curvatura	Pressione d'esercizio	Pressione di scoppio	Tolleranza Tolerance Toleranz Tolérance Tolerancia Tolerância	Pack.
					a/at 20°C bar	a/at 20°C bar		
TSFE 00 425	NT	4	2.5	21	22	110	± 0.07	1
TSFE 00 640	NT	6	4	36	19	96	± 0.07	1
TSFE 00 860	NT	8	6	64	14	70	± 0.07	1
TSFE 01 080	NT	10	8	100	11	55	± 0.07	1
TSFE 12 100	NT	12	10	144	9	45	± 0.07	1



Temperatura d'uso

Temperature Range

Temperaturbereich

Température d'utilisation

Temperatura de Ejercicio

Temperatura de Trabalho



- 60 °C

+ 205 °C

Tabella delle pressioni espresse in % in funzione della temperatura
 Table of pressure values expressed in% as a function of temperature
 Tabelle in Abhängigkeit Der Temperaturen Die Druckwerte In % Angegeben
 Valeurs de pression (en %) en fonction de la température
 Tabla de las presiones expresadas en % en función de la temperatura
 Tabela das pressões expressas em % em função da temperatura

20°	50°	100°	150°
100%	80%	45%	20%

TBPF**TUBO FLESSIBILE IN PTFE**

PTFE FLEXIBLE TUBE
 FLEXIBLES ROHR AUS PTFE
 TUBE FLEXIBLE EN PTFE
 TUBO FLEXIBLE EN PTFE
 TUBO FLEXÍVEL DE PTFE



Anti UV

Code	Colore Color Farbe Couleur Color Cor	Est. mm	Int. mm	Raggio di curvatura Bending radius Biegeradius Rayon de courbure Radio curvatura Raio de curvatura	Pressione d'esercizio Working pressure Betriebsdruck Pression de travail Presión de ejercicio Pressão de trabalho	Pressione di scoppio Burst pressure Berstdruck Pression d'éclatement Presión de rotura Pressão de ruptura	Tolleranza Tolerance Toleranz Tolérance Tolerancia Tolerância	Pack. Mt
TBPF 00 420	NT	4	2	16	35	110	± 0.10	50
TBPF 00 427	NT	4	2.7	25	21	65	± 0.10	50
TBPF 00 530	NT	5	3	25	28	85	± 0.10	50
TBPF 00 640	NT	6	4	36	23	70	± 0.10	50
TBPF 00 860	NT	8	6	64	15	50	± 0.15	50
TBPF 01 080	NT	10	8	100	13	40	± 0.20	50
TBPF 01 210	NT	12	10	144	10	30	± 0.20	50

Applicazioni Industriali

IT

- Trasporto Fluidi
- Alimentare Food & Beverage
- Elettrodomestici
- Elettronico
- Automobilistico e motociclistico
- Impianti medicali e di laboratorio
- Semiconduttori

Industrial Applications

GB

- Transport Fluids
- Food Food & Beverage
- Appliances
- Electronic
- Automotive and motorcycle
- Medical equipment and laboratory
- Semiconductors

Industrielle Anwendungen

DE

- Transport von Flüssigkeiten
- Essen & Trinken
- Haushaltgeräte
- Elektronik
- Automobile & Motorräder
- Medizin - & Labortechnik
- Halbleitertechnik

Applications industrielles

FR

- Transport de fluides
- Aliments & Boissons
- Electroménager
- Electronique
- Automobile et moto
- Equipement médical et de laboratoire
- Semi-conducteur

Aplicaciones industriales

ES

- Transporte de Fluidos
- Alimentaria Alimentos & Bebidas
- Electrodomésticos
- Electrónico
- Automovilístico y motociclistico
- Equipos médicos y laboratorios
- Semiconductores

Aplicações industriais

PT

- Transporte de Fluidos
- Indústria Alimentícias e de Bebidas
- Electrodomésticos
- Eletrónico
- Automobilístico e duas rodas
- Aplicações médicas e de laboratório
- Semi-condutores

**Temperatura d'uso**

Temperature Range

Temperaturbereich

Température d'utilisation

Temperatura de Ejercicio

Temperatura de Trabalho

- 60 °C
 + 260 °C



Tabella delle pressioni espresse in % in funzione della temperatura
 Table of pressure values expressed in % as a function of temperature
 Tabelle In Abhängigkeit Der Temperaturen Die Druckwerte In % Angegeben
 Valeurs de pression (en %) en fonction de la température
 Tabla de las presiones expresadas en % en función de la temperatura
 Tabela das pressões expressas em % em função da temperatura

20°	50°	100°	150°	200°	250°
100%	85%	65%	50%	35%	25%

SPIRALI IN POLIAMIDE SENZA CODOLI

SPIRALS POLYAMIDE WITHOUT TANGS
 SPIRALROHRE AUS POLYAMID OHNE GERADE ENDEN
 TUBE SPIRALÉ EN POLYAMIDE SANS EXTRÉMITÉS DROITES
 ESPIRALES EN POLIAMIDA SIN TERMINALES
 ESPIRAIS DE POLIAMIDA SEM ABAS

SS12

SPIRALE IN POLIAMIDE SENZA CODOLI

POLYAMIDE SPIRAL WITHOUT TANGS
 SPIRALROHRE AUS POLYAMID OHNE GERADE ENDEN
 TUBE SPIRALÉ EN POLYAMIDE SANS EXTRÉMITÉS DROITES
 ESPIRAL EN POLIAMIDA SIN TERMINALES
 ESPIRAL DE POLIAMIDA SEM ABAS



Code	Colore Color Farbe Couleur Color Cor	Est. mm	Int. mm	Ø Est. mm	Lunghezza Lineare Linear Length Gerade Länge Longueur Étirée Longitud Lineal Comprimento Linear Mt	Pressione d'esercizio	Pressione di scoppio	Tolleranza Tolerance Toleranz Tolérance Tolerancia	Pack.
						a/at 20°C bar	a/at 20°C bar		
SS12 0064 030	BL	6	4	63	30	27	81	± 0.10	1
SS12 0086 030	BL	8	6	87	30	20	60	± 0.10	1
SS12 0108 030	BL	10	8	106	30	15	45	± 0.12	1
SS12 0121 030	BL	12	10	135	30	13	39	± 0.15	1



Temperatura d'uso

Temperature Range

Temperaturbereich



Température d'utilisation

Temperatura de Ejercicio

Temperatura de Trabalho

- 40 °C

+ 70 °C

Tabella delle pressioni espresse in % in funzione della temperatura
 Table of pressure values expressed in% as a function of temperature
 Tabelle In Abhängigkeit Der Temperaturen Die Druckwerte In % Angegeben
 Valeurs de pression (en %) en fonction de la température
 Tabla de las presiones expresadas en % en función de la temperatura
 Tabela das pressões expressas em % em função da temperatura

-20°	0°	20°	30°	40°	50°	60°	70°
180%	140%	100%	90%	80%	70%	60%	50%

SPIRALI IN POLIURETANO POLIETERE 95 SHORE A CON CODOLI

SPIRALS POLYURETHANE POLYETHER 95 SHORE A WITH TANGS
 SPIRALROHRE AUS POLYURETHAN-POLYETHER 95 SHORE A MIT GERADEN ENDEN
 TUBE SPIRALÉ EN POLYURÉTHANE POLYÉTHÉR 95 SHORE A
 ESPIRALES EN POLIURETANO POLIÉTER 95 SHORE A CON TERMINALES
 ESPIRAIS DE POLIURETANO POLIÉTER 95 SHORE A COM ABAS

SDPU

SPIRALE IN POLIURETANO POLIETERE 95 SHORE A CON CODOLI

SPIRAL POLYURETHANE POLYETHER 95 SHORE A WITH TANGS
 SPIRALROHRE AUS POLYURETHAN-POLYETHER 95 SHORE A MIT GERADEN ENDEN
 TUBE SPIRALÉ EN POLYURÉTHANE POLYÉTHÉR 95 SHORE A AVEC EXTRÉMITÉS DROITES
 ESPIRAL EN POLIURETANO POLIÉTER 95 SHORE A CON TERMINALES
 ESPIRAL DE POLIURETANO POLIÉTER 95 SHORE A COM ABAS



Misura Size Größe Dimensions Tamaño	1	2
	mm	
6 - 4	100	100
8 - 5.5	120	500
10 - 6.5	120	500
12 - 8	120	500

Code	Colore Color Farbe Couleur Color Cor	Est.	Int.	Ø Est.	Lunghezza Lineare Linear length Gerade Länge Longueur étirée Longitud lineal Comprimento linear	Lunghezza a riposo	Lunghezza di Esercizio	Pressione d'esercizio	Pressione di scoppio	Tolleranza Tolerance Tolérance Tolerancia Tolerância	Pack.
						a/at 23°C	a/at 23°C	a/at 20°C	a/at 20°C		
		mm	mm	mm	Mt	mm	Mt	bar	bar	mm	
SDPU 0064 004	AZ	6	4	32	4	325	3	11	32	± 0.10	1
SDPU 0085 505	AZ	8	5.5	41	5	410	4	10	30	± 0.10	1
SDPU 0106 505	AZ	10	6.5	60	5	330	4	11	33	± 0.12	1
SDPU 0120 805	AZ	12	8	80	5	305	3	11	32	± 0.15	1
SDPU 0085 075	AZ	8	5.5	41	7.5	660	6	10	30	± 0.10	1
SDPU 0106 575	AZ	10	6.5	60	7.5	500	6	11	33	± 0.12	1
SDPU 0120 875	AZ	12	8	80	7.5	430	6	11	32	± 0.15	1



Temperatura d'uso

Temperature Range

Temperaturbereich

Température d'utilisation

Temperatura de Ejercicio

Temperatura de Trabalho

- 40 °C

+ 60 °C



Tabella delle pressioni espresse in % in funzione della temperatura
 Table of pressure values expressed in % as a function of temperature
 Tabelle in Abhängigkeit Der Temperaturen Die Druckwerte In % Angegeben
 Valeurs de pression (en %) en fonction de la température
 Tabla de las presiones expresadas en % en función de la temperatura
 Tabela das pressões expressas em % em função da temperatura

-20°	0°	20°	30°	40°	50°	60°
110%	100%	100%	85%	70%	60%	50%

New

KIT SOFFIAGGIO

BLOWER KIT
 GEBLÄSE-KIT
 KIT SOUFFLETTE
 KIT DE VENTILADOR
 KIT VENTILADOR



Temperatura d'uso

Temperature Range

Temperaturbereich

Température d'utilisation

Temperatura de Ejercicio

Temperatura de Trabalho



- 40 °C

+ 60 °C

Tabella delle pressioni espresse in % in funzione della temperatura
 Table of pressure values expressed in % as a function of temperature
 Tabelle In Abhängigkeit Der Temperaturen Die Druckwerte In % Angegeben
 Valeurs de pression (en %) en fonction de la température
 Tabla de las presiones expresadas en % en función de la temperatura
 Tabela das pressões expressas em % em função da temperatura

-20°	0°	20°	30°	40°	50°	60°
110%	100%	100%	85%	70%	60%	50%

SK001

SPIRALE IN POLIURETANO POLIETERE 95 SHORE A CON RACCORDO DIRITTO ORIENTABILE MASCHIO CILINDRICO

SPIRAL POLYURETHANE POLYETHER 95 SHORE A WITH ORIENTING STRAIGHT MALE ADAPTOR (PARALLEL)

SPIRALROHRE AUS POLYURETHAN-POLYETHER 95 SHORE A MIT GERADE EINSCHRAUBVERSCHRAUBUNG ZYLINDRISCH (DREHBAR)

TUBE SPIRALÉ EN POLYURÉTHANE POLYÉTHÉR 95 SHORE A AVEC RACCORD ORIENTABLE DROIT MÂLE CYLINDRIQUE

ESPIRAL EN POLIURETANO POLIÉTER 95 SHORE A CON RACOR RECTO ORIENTABLE MACHO CILÍNDRICO CON TÓRICA

ESPIRAL DE POLIURETANO POLIÉTER 95 SHORE A COM CONEXÃO RETA MACHO ORIENTÁVEL COM ROSCA PARALELA



Code	Colore Color Farbe Couleur Color Cor	Ø Int.	Ø Est.	Lunghezza Lineare Linear lenght Gerade Länge Longueur étirée Longitud lineal Comprimento linear	Filettatura Threads Gewindearten Filetages Roscas Roscas	Pack.
		mm	mm	Mt		
SK001 0640 02	AZ	4	6	2	1/4	1
SK001 0855 05	AZ	5.5	8	5	1/4	1
SK001 0855 75	AZ	5.5	8	7.5	1/4	1
SK001 1065 75	AZ	6.5	10	7.5	1/4	1
SK002 1208 75	AZ	8	12	7.5	3/8	1

SK010

SPIRALE IN POLIURETANO POLIETERE 95 SHORE A CON PISTOLE DI SOFFIAGGIO

SPIRAL POLYURETHANE POLYETHER 95 SHORE A WITH BLOW GUNS
 SPIRALROHRE AUS POLYURETHAN-POLYETHER 95 SHORE A MIT BLASPISTOLEN
 TUBE SPIRALÉ EN POLYURÉTHANE POLYÉTHÉR 95 SHORE A AVEC SOUFFLETTES
 ESPIRAL EN POLIURETANO POLIÉTER 95 SHORE A CON PISTOLAS SOPLADORAS
 ESPIRAL DE POLIURETANO POLIÉTER 95 SHORE A COM PISTOLA DE AR

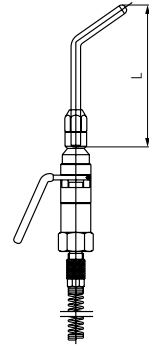

Code	Colore	Ø Int.	Ø Est.	L	Lunghezza Lineare	Filettatura	Pack.
	Color Farbe Couleur Color Cor						
SK010 0855 05	AZ	mm	mm	mm	Mt	1/4	1

SK022

SPIRALE IN POLIURETANO POLIETERE 95 SHORE A CON PISTOLE DI SOFFIAGGIO 362

SPIRAL POLYURETHANE POLYETHER 95 SHORE A WITH BLOW GUNS 362
 SPIRALROHRE AUS POLYURETHAN-POLYETHER 95 SHORE A MIT BLASPISTOLEN 362
 TUBE SPIRALÉ EN POLYURÉTHANE POLYÉTHÉR 95 SHORE A AVEC SOUFFLETTES 362
 ESPIRAL EN POLIURETANO POLIÉTER 95 SHORE A CON PISTOLAS SOPLADORAS 362
 ESPIRAL DE POLIURETANO POLIÉTER 95 SHORE A COM PISTOLA DE AR 362

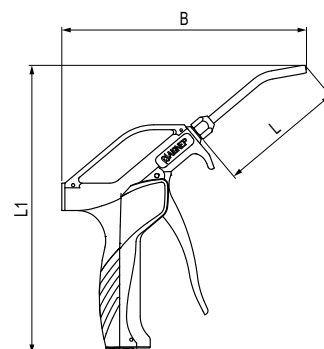

Code	Colore	Ø Int.	Ø Est.	L	L1	B	Lunghezza Lineare	Filettatura	Pack.
	Color Farbe Couleur Color Cor								
SK022 0855 05	NE	mm	mm	mm	mm	mm	Mt	1/4	1

TUBO PVC MULTISTRATO EXTRAFLESSIBILE

PVC MULTILAYER SUPERFLEXIBLE HOSE
MEHRSCICHTIGES PVC-ROHR SUPERFLEXIBEL
TUBE MULTICOUCHE SUPERFLEXIBLE PVC
TUBO MULTICAPA SUPERFLEXIBLE PVC
TUBO MULTICAMADA SUPERFLEXIVEIS PVC

TBPVM

TUBO PVC MULTISTRATO EXTRAFLESSIBILE - LUNGHEZZA 25 Mt

PVC MULTILAYER SUPERFLEXIBLE HOSE - LENGHT 25 Mt
MEHRSCICHTIGES PVC-ROHR SUPERFLEXIBEL - LÄNGE 25 Mt
TUBE MULTICOUCHE SUPERFLEXIBLE PVC - ROULEAU DE 25 Mt
TUPO MULTICAPA SUPERFLEXIBLE PVC - LONGITUD 25 Mt
TUBO MULTICAMADA SUPERFLEXIVEIS PVC - LUNGHEZZA 25 Mt



Temperatura d'uso

Temperature Range

Temperaturbereich

Température d'utilisation

Temperatura de Ejercicio

Temperatura de Trabalho

- 20 °C
+ 60 °C

Code	Colore Color Farbe Couleur Color Cor	Est. mm	Int. mm	Raggio di curvatura Bending radius Biegeradius Rayon de courbure Radio curvatura Raio de curvatura	Pressione d'esercizio Working pressure Betriebsdruck Pression de travail Presión de ejercicio Pressão de trabalho a/at 20°C	Pressione di scoppio Burst pressure Berstdruck Pression d'éclatement Presión de rotura Pressão de ruptura	Pack.
TBPVM 011 06	AZ	11	6,3	45	15	60	1
TBPVM 013 08	AZ	13	8	56	15	60	1
TBPVM 145 09	AZ	14,5	9	63	15	60	1
TBPVM 155 10	AZ	15,5	10	70	15	60	1
TBPVM 191 27	AZ	19	12,7	89	15	60	1
TBPVM 023 16	AZ	23	16	112	15	60	1

Applicazioni Industriali

- Industria in generale
- Industria automobilistica
- Industrie delle materie plastiche

Fluido compatibile

- Aria compressa

Industrial Applications

- Industry in general
- Automotive industry
- Plastics industry

Fluids

- Compressed air

Industrielle Anwendungen

- Industrie im allgemeinen
- Automobilindustrie
- Kunststoffindustrie

Geeignete Medien

- Druckluft

Applications industrielles

- Industries général
- Industries automobile
- Industries plastiques

Fluides compatibles

- Air comprimé

Aplicaciones industriales

- Industria en general
- Industria automotriz
- Industrias de plásticos

Fluidos compatibles

- Aire comprimido

Aplicações industriais

- Indústria em geral
- Indústria automotiva
- Indústrias de plásticos

Fluidos compatíveis

- Ar comprimido

1770

FASCETTA STRINGITUBO PER TUBI PVC

CLAMPS FOR PVC HOSES
KLEMMEN FÜR PVC-ROHRE
COLLIERS DE SERRAGE POUR TUBES PVC
ABRAZADERAS PARA TUBO PVC
ABRAÇADEIRA POR TUBO PVC



Code	D	B	S	Pack.
01770 00 001	8 - 12	9 mm	0.6 mm	50
01770 00 002	10 - 16	9 mm	0.6 mm	50
01770 00 003	12 - 20	9 mm	0.6 mm	50
01770 00 004	16 - 27	9 mm	0.6 mm	50

TUBO PVC FOOD GRADE

PVC TUBE FOOD GRADE
 PVC ROHR LEBENSMITTELKONFORM
 TUYAU PVC QUALITE ALIMENTAIRE
 TUBO PVC FOOD GRADE
 TUBO EM PVC ALIMENTÍCIO (FOOD GRADE)

TBPV

TUBO PVC FOOD GRADE

PVC TUBE FOOD GRADE
 PVC SCHLAUCH FOOD GRADE
 TUBES PVC FOOD GRADE
 TUBO PVC FOOD GRADE
 TUBO PVC FOOD GRADE



Temperatura d'uso

Temperature Range

Temperaturbereich

Température d'utilisation

Temperatura de Ejercicio

Temperatura de Trabalho

- 5 °C
 + 60 °C

Code	Colore Color Farbe Couleur Color Cor	Est. mm	Int. mm	Pressione d'esercizio Working pressure Betriebsdruck Pression de travail Presión de ejercicio Pressão de trabalho	Pressione d'esercizio Working pressure Betriebsdruck Pression de travail Presión de ejercicio Pressão de trabalho	Pressione d'esercizio Working pressure Betriebsdruck Pression de travail Presión de ejercicio Pressão de trabalho	Pressione di scoppio Burst pressure Berstdruck Pression d'éclatement Presión de rotura Pressão de ruptura	Pack. Mt
				a/at 20°C bar	a/at 40°C bar	a/at 60°C bar	a/at 20°C bar	
TBPV 01 370	NT	13	7	20	16	12	60	100
TBPV 16 100	NT	16	10	18	13	9	54	100
TBPV 23 150	NT	23	15	10	7	4	30	50
TBPV 26 190	NT	26	19	10	7	4	30	50
TBPV 33 250	NT	33	25	8	5	3	24	50

Applicazioni Industriali

IT

- Liquidi di Raffreddamento
- Soluzioni Chimiche
- Per Industria alimentare
- Aria Compressa

Materiale

- Acciaio plastificato con rinforzo interno in fibra poliestere

Industrial Applications

GB

- Cooling Liquids
- Chemical Solutions
- Food Industry
- Compressed Air

Materials

- Soft Steel hose with polyester reinforcement

Industrielle Anwendungen

DE

- Kühlmittel
- Chemische Lösungen
- Lebensmittelindustrie
- Druckluft

Materialien

- Stahl-Schlauch mit Polyesterverstärkung

Applications industrielles

FR

- Liquide de Refroidissement
- Solutions chimiques
- Industrie alimentaire
- Air comprimé

Matériaux

- Tuyau en Acier avec renfort en polyester

Aplicaciones industriales

ES

- Líquidos de Enfriamiento
- Soluciones químicas
- Industria de Alimentos
- Aire Comprimido

Materiales

- Acero plastificado con refuerzo de hilo de poliéster

Aplicações industriais

PT

- Líquidos de refrigeração
- Soluções químicas
- Indústria Alimentícia
- Ar Comprimido

Materiais

- Aço plastificado com reforço de fios de poliéster

TUBO AUTOBLOCCANTE

PUSH-LOCK HOSE
SCHNELLSTECKSCHLÄUCHE
TUYAU AUTO-SERRANT
TUBO AUTOBLOCANTE
TUBO PUSH-LOCK



CARATTERISTICHE TECNICHE

TECHNICAL CHARACTERISTICS
TECHNISCHE ANGABEN
CARACTÉRISTIQUES TECHNIQUES
CARACTERÍSTICAS TÉCNICAS
CARACTERÍSTICAS TÉCNICAS

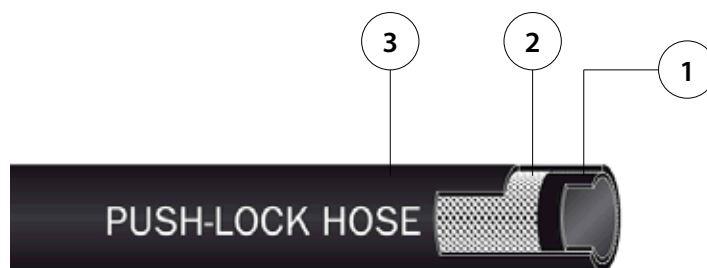

Materiali	IT	Materials	GB	Materialien	DE
1 Sottostrato: NBR/PVC liscio resistente agli oli.		1 Sublayer: NBR/PVC smooth, oil resistant.		1 Innenrohr: NBR/PVC glatt, Öl.	
2 Armatura: Tela Tessile.		2 Armor: Cloth Textiles.		2 Gewebeeinlage: Synthetische Textilfasern.	
3 Rivestimento: NBR/PVC liscio resistente alle abrasioni, agli oli e agli agenti atmosferici.		3 Finish: NBR/PVC smooth, abrasion, oil and weather resistant.		3 Aussenschicht: NBR/PVC glatt, Abriebfest, Öl- und Witterungsbeständig.	
Materiaux	FR	Materiales	ES	Materiais	PT
1 Tube: NBR/PVC lisse, résistant aux huiles.		1 Tubo interior: NBR/PVC liso resistente a los aceites.		1 Tubo interior: NBR/PVC suave resistente a óleos.	
2 Armature: Fibres textiles.		2 Armadura: Trenza Textil		2 Armadura: Trançado Têxtil	
3 Revêtement extérieur: NBR/PVC lisse, résistant à l'abrasion, aux huiles et aux intempéries.		3 Tubo exterior: NBR/PVC liso resistente a la abrasión, a los aceites y a los agentes atmosféricos.		3 Tubo exterior: NBR/PVC suave resistência a abrasão, a óleos, a agentes atmosférico.	

COLORI STANDARD
STANDARD COLORS
STANDARD FARBEN
COULEURS STANDARDS
CORES PADRÃO

	RO	ROSSO RED ROT ROUGE ROJO VERMELHO
	BL	AZZURRO LIGHT BLUE HELLBLAU BLEU CLAIR AZUL AZUL CLARO
	VE	VERDE GREEN GRÜN VERT VERDE VERDE
	NE	NERO BLACK SCHWARZ NOIR NEGRO PRETO



Temperatura con aria compressa Temperature with compressed air Mit Druckluft Avec de l'air comprimé Con aire comprimido Com ar comprimido	-20°C	+110°C
		con picchi di 125°C peak +125°C Kurzfristig +125°C Pic à +125°C con picos de +125 °C com picos de + 125 °C
Temperatura con acqua Temperature with water Mit Wasser Avec de l'eau Con Agua Com Água	0°C	+100°C
		con picchi di 110°C peak +110°C Kurzfristig +110°C Pic à +110°C con picos de +110 °C com picos de + 110 °C
Temperatura con olio idraulico Temperature with hydraulic oil Mit Hydrauliköl Avec de l'huile hydraulique Con aceites hidráulicos Com óleos hidráulicos	-20°C	+70°C
		con picchi di 90°C peak +90°C Kurzfristig +90°C Pic à +90°C con picos de +90 °C com picos de + 90 °C
Temperatura con Acqua Glicole Temperature with Water Glycol Mit Glykolwasser Avec de l'eau glycolé Con Agua Glicol Com Água e Glicol	-20°C	+70°C
		con picchi di 90°C peak +90°C Kurzfristig +90°C Pic à +90°C con picos de +90 °C com picos de + 90 °C



Pressioni

Pressures

Druckbereich

Pressions

Presiones

Pressões

16 bar (1.6 MPa)



Fluidi compatibili

Aria compressa / Acqua / Olio Idraulico / Acqua Glicole / Gasolio / Benzina

Fluids

Compressed air / Water / Hydraulic Oil / Water Glycol / Diesel Fuel / Petrol

Geeignete Medien

Druckluft / Wasser / Hydrauliköl / Glykolwasser / Dieselkraftstoff / Benzin

Fluides compatibles

Air comprimé / Eau / Huile Hydraulique / Eau glycolé / Carburant diesel / Essence

Fluidos compatibles

Aire comprimido / Agua / Aceite hidráulico / Agua Glicol / Combustible Diesel / Gasolina

Fluidos compatíveis

Ar comprimido / Água / Óleo hidráulico / Água e Glicol / Combustível Diesel / Gasolina

TBPL

TUBO AUTOBLOCCANTE

PUSH-LOCK HOSE

SCHNELLSTECKSCHLÄUCHE

TUYAUX AUTO-SERRANTS

TUBERÍA AUTOBLOCANTE

TUBO PUSH-LOCK



Code	Code	Code	Code	Int.	Int.	Est.	Raggio di curvatura Bending radius Biegeradius Rayon de courbure Radio curvatura Raio de curvatura	Pressione d'esercizio Working pressure Betriebsdruck Pression de travail Presión de ejercicio Pressão de trabalho	Pressione di scoppio Burst pressure Berstdruck Pression d'éclatement Presión de rotura Pressão de ruptura	Pack.
				inch	mm	mm	mm	a/at 23°C bar	a/at 23°C bar	Mt
TBPL 1/4 0 RO 100	TBPL 1/4 0 BL 100	TBPL 1/4 0 VE 100	TBPL 1/4 0 NE 100	1/4	6.3	12.4	45	16	64	100
TBPL 3/8 0 RO 100	TBPL 3/8 0 BL 100	TBPL 3/8 0 VE 100	TBPL 3/8 0 NE 100	3/8	9.6	15.5	75	16	64	100
TBPL 1/2 0 RO 100	TBPL 1/2 0 BL 100	TBPL 1/2 0 VE 100	TBPL 1/2 0 NE 100	1/2	12.7	18.7	90	16	64	100
TBPL 5/8 0 RO 080	TBPL 5/8 0 BL 080	TBPL 5/8 0 VE 080	TBPL 5/8 0 NE 080	5/8	16	22.9	115	16	64	80
TBPL 3/4 0 RO 080	TBPL 3/4 0 BL 080	TBPL 3/4 0 VE 080	TBPL 3/4 0 NE 080	3/4	19.2	26.5	135	16	64	80

Vedi raccordi da utilizzare Cap. 17 - p. 32-33-34.

See Push-lock fittings on Chapter 17 - p. 32-33-34.

Siehe dazu passende Verschraubungen im Kapitel 17 - p. 32-33-34.

A utiliser avec les douilles annelées chap.17 - p. 32-33-34.

Ver racores a utilizar Cap. 17 - p. 32-33-34.

Veja conexões a serem utilizadas no Cap.17 - p. 32-33-34.

ACCESSORI

ACCESSORIES
ZUBEHÖR
ACCESSOIRES
ACCESORIOS
ACESSÓRIOS

SEAL01

SIGILLAFILETTI
THREAD SEALANT
SCHRAUBENSICHERUNG
ÉTANCHÉITÉ FILETÉE
SELLANTE DE ROSCAS
VEDANTE DE ROSCAS



New

Code	Size	Pack.
SEAL01	75 ml - 82 g	10

Utilizzare con aria compressa, gas naturale, acqua potabile (trascorse 24h dall'applicazione) e gas.
Use with compressed air, natural gas, drinking water (after 24 hours from application) and gases.
Anwendung mit Druckluft, Erdgas, Trinkwasser (nach 24 Stunden nach der Anwendung) und Gase.
Utiliser avec de l'air comprimé, gaz naturel, eau potable (24 heures après l'application) et gaz.
Aplicación con aire comprimido, gas natural, agua potable (después 24 horas de la aplicación) y gases.
Aplicação com ar comprimido, gás natural, água potável (após 24 horas da aplicação) e gases.

NAFE

NASTRO IN PTFE
PTFE TAPE
TEFLONBAND PTFE
BANDE FLUOROPOLYMÈRE
ROLLO PTFE
FITA EM PTFE



Code	Size	Pack.
NAFE01 20 10 12	12 mm x 0.1 mm x 12 Mt	10

1740

STAFFA FISSA TUBO
FIXED BRACKET TUBE
CLIPLEISTE
CLIP DE FIXATION
BRIDAS PARA TUBO
SUPORTE FIXA-TUBO



Code	Tube Position	Pack.
01740 00 001	10 x 4 mm	10
01740 00 002	10 x 6 mm	10
01740 00 003	10 x 8 mm	10
01740 00 004	10 x 10 mm	10
01740 00 005	8 x 12 mm	10
01740 00 006	8 x 14 mm	10

0 °C
+ 40 °C

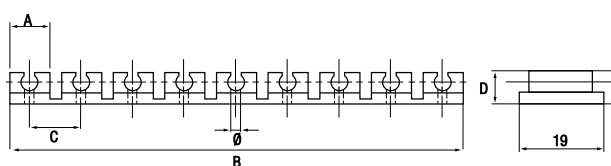

Ø Tube mm	A mm	B mm	C mm	D mm	Ø mm	N° posizioni N° positions Anzahl Positionen Nombre fixations N° de posições
4	9	114	11.7	8	2.8	10
6	9	114	11.7	10	2.8	10
8	12	143	14.6	12	3.8	10
10	15	172	17.4	13.8	5.3	10
12	19	76	20.5	16.8	5.3	8
14	21	87	22.5	18.8	5.3	8

Vantaggi nelle applicazioni

IT

- Installazione rapida
- Ingombri ridotti
- Inattaccabili da agenti atmosferici
- Ottima resistenza alle vibrazioni
- Fissaggio rapido del tubo con semplice pressione

Advantages in applications

GB

- Quick fitting
- Space Saving
- Weather ability
- Excellent resistance to vibrations
- Quick tube fitting by simple pressure

Anwendungs Vorteile

DE

- Schnelle Montage
- Platzsparend
- Wetterfest
- Sehr gute Vibrationsbeständigkeit
- Schneller Rohranschluss durch einfaches Drücken

Avantages dans les applications

FR

- Fixation rapide
- Encombrement réduit
- Bonne tenue
- Excellente résistance aux vibrations
- Accrochage rapide du tube par simple pression

Ventajas en las aplicaciones

ES

- Rápida instalación
- Reducidas dimensiones
- Resistente de agentes atmosféricos
- Óptima resistencia a la vibración
- Fijación rápida del tubo con una simple presión

Vantagens em aplicações

PT

- Conexão rápida
- Redução de espaço
- Resistência a intempéries e à agentes atmosféricos
- Excelente resistência a vibração
- Encaixe do tubo com força reduzida

1750**TAGLIATUBO IN TECNOPOLIMERO**

TECHNOPOLYMER PIPE CUTTER
ROHRSCHEIDER KUNSTSTOFF
COUPE TUBE POUR TUBE PLASTIQUE
CORTATUBOS EN PLÁSTICO
CORTADOR DE TUBOS EM PLÁSTICO



Code	Size	Pack.
01750 00 001	14 mm Max	10

1752**TAGLIATUBO IN METALLO PER TUBI PLASTICI**

METAL CUTTER FOR PLASTIC PIPE
ROHRSCHEIDER
PINCE COUPE-TUBES
CORTATUBO METÁLICO
ALICATE METÁLICO CORTA-TUBOS



Code	Tube	Pack.
01752 00 001	15.5 mm Max	1
01752 00 002	25 mm Max	1

1753**LAMA DI RICAMBIO PER 1752**

SPARE BLADE 1752
ERSATZKLINGEN FÜR 1752
LAMES DE RECHANGE POUR 1752
CUCHILLA DE RECAMBIO PARA 1752
LÂMINA DE REPOSIÇÃO PARA 1752



Code	Tube	Pack.
01753 00 001	15.5 mm Max	5
01753 00 002	25 mm Max	5

1755**PINZA TAGLIA TUBO ANTISCINTILLA**

ANTI-SPARK TUBE CUTTER
SCHNEIDER FÜR SCHWEISSSPRITZABWEISENDES ROHR
PINCE DE DEGAINAGE POUR TUBE ANTI ETINCELLE
PINZA CORTA TUBO ANTICHISPA
PINÇA CORTA-TUBOS PARA TUBO ANTI-CHAMA



Code	Tube	Pack.
01755 00 001	6 - 8 mm	1
01755 00 002	10 - 12 mm	1

Архангельск (8182)63-90-72
Астана (7172)727-132
Астрахань (8512)99-46-04
Барнаул (3852)73-04-60
Белгород (4722)40-23-64
Брянск (4832)59-03-52
Владивосток (423)249-28-31
Волгоград (844)278-03-48
Вологда (8172)26-41-59
Воронеж (473)204-51-73
Екатеринбург (343)384-55-89
Иваново (4932)77-34-06

Ижевск (3412)26-03-58
Иркутск (395)279-98-46
Казань (843)206-01-48
Калининград (4012)72-03-81
Калуга (4842)92-23-67
Кемерово (3842)65-04-62
Киров (8332)68-02-04
Краснодар (861)203-40-90
Красноярск (391)204-63-61
Курск (4712)77-13-04
Липецк (4742)52-20-81
Киргизия (996)312-96-26-47

Магнитогорск (3519)55-03-13
Москва (495)268-04-70
Мурманск (8152)59-64-93
Набережные Челны (8552)20-53-41
Нижний Новгород (831)429-08-12
Новокузнецк (3843)20-46-81
Новосибирск (383)227-86-73
Омск (3812)21-46-40
Орел (4862)44-53-42
Оренбург (3532)37-68-04
Пенза (8412)22-31-16
Казахстан (772)734-952-31

Пермь (342)205-81-47
Ростов-на-Дону (863)308-18-15
Рязань (4912)46-61-64
Самара (846)206-03-16
Санкт-Петербург (812)309-46-40
Саратов (845)249-38-78
Севастополь (8692)22-31-93
Симферополь (3652)67-13-56
Смоленск (4812)29-41-54
Сочи (862)225-72-31
Ставрополь (8652)20-65-13
Таджикистан (992)427-82-92-69

Сургут (3462)77-98-35
Тверь (4822)63-31-35
Томск (3822)98-41-53
Тула (4872)74-02-29
Тюмень (3452)66-21-18
Ульяновск (8422)24-23-59
Уфа (347)229-48-12
Хабаровск (4212)92-98-04
Челябинск (351)202-03-61
Череповец (8202)49-02-64
Ярославль (4852)69-52-93

<https://aignep.nt-rt.ru/> || afp@nt-rt.ru